

APPENDIX C-WSTP AUTOMATION DESIGN GUIDE

	Automation Design Guide	Revision: 03	Page 1 of 132
		Document Code: 612620-0013-40ER-0001	



The City of Winnipeg
Water & Waste Department

Wastewater Treatment Facilities
Automation Design Guide

Document Code:
 Revision: 03

Approved By:	 <hr style="border: 0; border-top: 1px solid black; margin: 5px 0;"/> Colin Jarra, P.Eng Project Director – Winnipeg Sewage Treatment Program	March 7, 2023 <hr style="border: 0; border-top: 1px solid black; margin: 5px 0;"/> Date
--------------	---	--



Automation Design Guide

Revision: 03 Page 3 of 132

Document Code: 612620-0013-40ER-0001

REVISION REGISTER

Rev.	Description	Date	By	Checked	Approved
00	Issued for City Use	2015-08-19	B. Clevon	T. Church	T. Church
01	Revisions Accepted	2019-06-19	D. S. Allen	M. Mulligan	D. Griffin
02	Revisions Accepted	2021-09-21	K. Schimke	R. Salunga/ M. Mulligan	C. Javra
03	Revisions Accepted	2023-02-17	K. Schimke	R. Salunga/ M. Mulligan	C. Javra



Automation Design Guide

Revision: 03 Page 4 of 132

Document Code: 612620-0013-40ER-0001

This page is intentionally blank.

TABLE OF CONTENTS

1	Introduction	11
1.1	Scope of the Guide	11
1.2	Application	11
1.3	Acronyms and Abbreviations	12
1.4	Definitions	14
2	General.....	17
2.1	References	17
2.1.1	General	17
2.1.2	City of Winnipeg Standards	17
2.1.3	Codes and Standards	17
2.1.4	Local Codes and Bylaws	17
2.2	Units of Measure	18
3	Process Control System.....	19
3.1	General	19
3.2	Existing DCS	19
3.3	Architecture Overview	19
3.4	Communication Networks.....	21
3.4.1	General	21
3.4.2	Facility-Wide Fibre Backbone Ring Network	21
3.4.3	Process Control System Network.....	22
3.4.4	Network Routing	25
3.4.5	Network Equipment and Cabling	26
3.4.6	Wireless Networking.....	27
3.5	HMI and Historian Server Systems	27
3.5.1	General	27
3.5.2	HMI Clients	27
3.5.3	DMZ HMI Terminal Servers.....	28
3.5.4	Historian Server.....	28
3.6	Modification of HMI Systems	29
3.7	Domain Controller.....	29
3.8	Server Virtualization	29
3.9	Programming/Maintenance Workstations	29
3.10	Programmable Logic Controllers.....	30
3.10.1	PLC to Replace an Existing DCS PCU	31
3.10.2	PLCs for New Wastewater Treatment Process Equipment or Independent Critical Equipment	31
3.10.3	PLCs for a Minor Process Train or Auxiliary Equipment	32
3.10.4	Packaged PLC from Equipment Vendor	33
3.11	Standardized PLC Hardware.....	33
3.12	Standard Architectures	36
3.13	PLC Programs	42
3.13.1	Program Language	42
3.13.2	PLC Configurations and Program Logic.....	42

	3.13.3 Program Structure	42
	3.13.4 Program Documentation.....	43
	3.13.5 Variable Data Types	43
	3.14 Control Modes	43
	3.15 Cyber Security	44
4	I/O Requirements	47
5	Identification.....	48
6	Packaged Equipment Systems	49
	6.1 Introduction	49
	6.1.1 Scenario 1 - Comprehensive Vendor Supply	49
	6.1.2 Scenario 2 – Comprehensive Vendor Supply - City Hardware and Software Standards	50
	6.1.3 Scenario 3 –Vendor Hardware Supply - City Hardware Standards	51
	6.1.4 Scenario 4 – Custom Designed Approach	52
	6.2 Understanding of the City’s Priorities	53
7	Layout / Location Requirements.....	55
	7.1 Control Panels	55
	7.1.1 PLC Panels.....	55
	7.1.2 Remote I/O Panels	55
	7.1.3 Power.....	55
8	Environmental Requirements	56
	8.1 Ingress Protection.....	56
	8.2 Temperature and Humidity Ratings.....	56
	8.3 Cold Environment Requirements	56
9	Wiring, Cabling, and Conduit	57
	9.1 Standard Colours.....	57
	9.1.1 Control Wiring – Wire Colour.....	57
	9.1.2 Network Cable – Jacket Colour.....	57
	9.1.3 Profibus Cable – Conductor Colour.....	57
	9.1.4 Conduit Colour Coding	58
	9.2 Cable Types and Ratings	58
	9.2.1 Cable Requirements.....	58
	9.3 Use of Conduits vs. Cables	59
	9.4 Conduit Materials and Sizes.....	60
	9.5 Junction Boxes	60
	9.6 Cable Trays	61
	9.7 Shield Termination and Grounding.....	61
	9.8 Signal Noise Prevention	62
10	HMI Systems.....	63
	10.1 Locations	63
	The HMI clients will include desktop clients in the main control rooms and in area control rooms or determined by contract. Where walking distance to a control room is excessive, local ruggedized touchscreen terminals shall be provided near process equipment. The network connections to all fixed field operator workstations shall be hardwired.	63
	10.2 Standards	63

10.3	HMI Standards and Reference Material	64
11	Local User Interface	65
11.1	General	65
11.2	Pilot Device Colours	65
11.3	Touchscreen HMIs	66
11.4	Typical Manual Controls	66
12	Control Panels	67
12.1	Heating, Ventilation, and Cooling	67
12.2	Spare Space	67
12.3	Wireways	67
12.4	Cable Entry	68
12.5	Power Supply Voltage	68
12.6	Control Voltage	68
12.7	Grounding and Bonding	68
12.8	Terminals	69
12.9	Terminals for Hardwired I/O Terminations	70
12.10	Lighting	70
12.11	Shelves	70
12.12	Laptop Receptacle	71
13	Motor Control	72
13.1	Standard Equipment	72
13.2	Control and Monitoring	72
13.2.1	General	72
13.2.2	Low Voltage Motor Control Centres	72
13.2.3	Low Voltage Variable Frequency Drives	74
13.2.4	Medium Voltage Motors	76
13.2.5	Automatic Restart	76
14	Valve Control	77
14.1	General	77
14.2	Control and Monitoring	77
15	SPecific Application Requirements	80
15.1	Building Mechanical Systems	80
16	Instrumentation	81
16.1	General Requirements	81
16.2	Typical Practices	81
16.2.1	Fail-Safe Implementation	81
16.2.2	Routing of Signal Cabling	81
16.2.3	Instrument Redundancy	81
16.2.4	Installation and Removal	82
16.2.5	Instrument Displays	82
16.2.6	Instrument Manifolds	82
16.2.7	Gas Detection Equipment	82
16.2.8	Hazardous Location Door Entry Stations	82
16.3	Selection Criteria	83
16.3.1	Standardized Manufacturers	83
16.3.2	Instrument Accuracy	83

16.3.3	Transmitter Output.....	83
16.3.4	Switches vs. Transmitters.....	84
16.3.5	Instrument Power Supply	84
16.3.6	Materials	85
16.3.7	Flow Measurement Instruments	85
16.3.8	Level Measurement Instruments	86
16.3.9	Pressure Measurement Instruments	86
16.3.10	Temperature Measurement Instruments	86
16.4	Application Requirements.....	86
16.4.1	HVAC – Air Systems	86
16.4.2	Building Sumps (Non-Process)	91
16.4.3	Gas Detection.....	91
16.4.4	Permanent Gas Detection	92
16.4.5	Chemical Rooms	93
16.4.6	Smoke Detectors	93
16.4.7	Security.....	94
17	Power Supply	95
17.1	General Requirements	95
17.2	24 Vdc Power Supplies	95
17.3	UPS Power	95
18	Hazardous Locations	97
18.1	General.....	97
18.2	References	97
18.3	Design Requirements	98
18.3.1	General.....	98
18.3.2	Intrinsically Safe Systems.....	98
18.4	Preferred Methods of Protection	99
18.4.1	General.....	99
18.4.2	Zone 0 Locations	99
18.4.3	Zone 1 Locations	99
18.4.4	Zone 2 Locations.....	99
19	Safety Instrumented Systems	100
19.1	General.....	100
19.2	Documentation Requirements	101
19.3	General Design Principles.....	101
20	Grounding.....	103
20.1	General.....	103
20.2	Implementation of Automation Equipment Grounding	103
20.2.1	Installations in Existing Buildings	103
20.2.2	Installations in New Buildings.....	104
20.2.3	Typical Configurations	104
20.3	Minimum Requirements.....	106
20.4	Good Practices	107
21	Automation Rooms	108
21.1	Location of Equipment.....	108
21.2	General Requirements	108
21.3	Space and Location Requirements	108

22	Engineering Design Team Responsibility.....	109
22.1	General.....	109
22.2	Drawings.....	110
22.2.1	Architecture Block Diagrams.....	110
22.2.2	Loop Drawings.....	110
22.2.3	Instrument Segment Drawings.....	111
22.2.4	Instrument Location Plan Drawings.....	112
22.2.5	Instrument Installation Details.....	112
22.2.6	Control Panel Layouts.....	113
22.2.7	Control Panel Power Distribution Schematics.....	113
22.2.8	I/O Module Wiring Diagrams.....	114
22.2.9	Network Diagrams.....	114
22.2.10	Automation Conduit Riser Diagrams.....	115
22.2.11	Process and Instrumentation Diagrams.....	116
22.3	Other Documents.....	116
22.3.1	Instrument List.....	117
22.3.2	Loop Numbering List.....	117
22.3.3	I/O List.....	118
22.3.4	Interface Maps.....	119
22.3.5	Automation Cable Schedule.....	119
22.3.6	Lamacoid Schedule.....	120
22.3.7	Process Control Narrative.....	121
22.3.8	Functional Requirements Specifications.....	122
22.4	Construction and Commissioning Documents.....	122
22.4.1	Instrument Test Forms.....	122
22.4.2	I/O Module Test Forms.....	123
22.4.3	PLC System Commissioning Checklist.....	124
22.4.4	SCADA System Commissioning checklist.....	125
22.4.5	Valve Actuator Commissioning Checklist.....	126
22.5	Design Calculations and Studies.....	127
23	Sample Drawings.....	129
24	Sample Documents.....	130

	Automation Design Guide	Revision: 03	Page 11 of 132
		Document Code: 612620-0013-40ER-0001	

1 INTRODUCTION

This Wastewater Department Automation Design Guide is intended to serve as a reference for consistent design of new automation systems for City of Winnipeg owned wastewater facilities. This document provides guidance to department personnel, as well as external consultants, in the design of automation systems for the Winnipeg Sewage Treatment Program (WSTP), and also indicates the expectations and responsibilities of the designers.

1.1 Scope of the Guide

These design requirements will apply to the following facilities:

1. North End Water Pollution Control Centre (NEWPCC),
2. South End Water Pollution Control Centre (SEWPCC),
3. West End Water Pollution Control Centre (WEWPCC).

These design requirements will also be applied to the collection system where relevant and useful.

1.2 Application

The scope and intent of this document is to convey general design guidance regarding automation systems at wastewater facilities. This document addresses specifics related to equipment type, selection, and configuration; however, the guidance is presented without knowledge of the specific process implementation. It is not within the scope of this document to provide detailed design direction, and it will be the responsibility of the respective system designers to fully develop the automation design details with general conformance, as appropriate, for the concepts presented herein. This guide shall not be construed as comprehensive engineering design requirements or negate the requirement for professional engineering involvement. Any design must be executed under the responsibility and seal of the respective engineer in each instance, and must be performed in conformance with all applicable codes and standards, as well as good engineering practice, with due consideration for other relevant issues such as equipment warranties, statutory certifications, and the like.

Where significant deviations from this guide are deemed to be appropriate by the design engineer, these shall be subject to further review and acceptance by all stake holders.

Existing facilities do not necessarily comply with this guide. The expectations regarding application of this guide to new designs at existing facilities must be assessed on a case-by-case basis; however general guidelines for application are presented as follows:

- All new designs, not related to an existing facility, are expected to be subject to the utilization of this guideline.
- All major upgrades to a facility, or a larger facility's process area, are expected to be subject to the utilization of this guideline, however in some cases compromise with the configuration of the existing facility design may be required based on input from any stake holder.
- All minor upgrades should use this guide as far as practical for new equipment, however in some cases compromise with the configuration of the existing facility design and installation which will be retained after an upgrade will be required based on input from any stake holder.

Where a requirement is indicated with the word "should", the designer may deviate from the indicated requirement provided that:

- the rationale for deviation is reasonable and logical from a design perspective;

	Automation Design Guide	Revision: 03	Page 12 of 132
		Document Code: 612620-0013-40ER-0001	

- the chosen design solution provides a solution that equivalently meets the intent; and
- The City is in no way disadvantaged by the alternate design solution
- The developer submits documentation detailing deviation to the City for approval.

The model numbers provided within this document are indicative of preferred equipment with features required by the City (at the time of writing). In addition, the City is/would be likely to carry stock spares parts of and/or replacement units of the indicated models. The indicated model number should be utilized where these models are still current, actively marketed and fully meet the project requirements without any disadvantage to the City. Where a newer/replacement model is available that satisfies the minimum requirements, and has additional features that would benefit the City, the newer models shall be utilized in place of current models, as required to meet the project requirements,

1.3 Acronyms and Abbreviations

A	Amperes
ACIC	Armoured Control and Instrumentation Cable
BPCS	Basic Process Control System
CIC	Control and Instrumentation Cable (Non-Armoured)
CPT	Control Power Transformer
CPU	Central Processing Unit
CSA	Canadian Standards Association
CV	Control Variable (PID Control)
d	Flame-proof
DCS	Distributed Control System
DIO	Distributed I/O
DMZ	Demilitarized Zone
DP	Decentralized Periphery (PROFIBUS DP protocol)
DRS	Dual Ring Switch (Ethernet Switch)
EDDL	Electronic Device Description Language - IEC 61804
EMT	Electrical Metallic Tubing
FAT	Factory Acceptance Test
GSD	General Station Description (description of the PROFIBUS DP/PA or PROFINET device)
JB	Junction Box
HMI	Human Machine Interface
HOA	Hand - Off - Auto (switch)
HOR	Hand - Off - Remote (switch)
HP, hp	Horsepower

	Automation Design Guide	Revision: 03	Page 13 of 132
		Document Code: 612620-0013-40ER-0001	

HSBY	Hot Standby
HVAC	Heating Ventilation and Cooling
I/O	Input / Output
ia	Intrinsic Safety Level, Zone 0
ib	Intrinsic Safety Level, Zone 1
ic	Intrinsic Safety Level, Zone 2
IEC	International Electrotechnical Commission
IEEE	Institute of Electrical and Electronics Engineers
IS	Intrinsically Safe
IT	Information Technology
LHMI	Local HMI (dedicated to a specific piece of equipment)
LOR	Local - Off - Remote (switch)
MCC	Motor Control Centre
MOA	Manual - Off - Auto (switch)
MRP	Media Redundancy Protocol
MTBF	Mean Time Between Failure
NEMA	National Electrical Manufacturers Association
NFPA	National Fire Protection Association
PA	Process Automation (PROFIBUS PA protocol)
PB	Pull Box
PCS	Process Control System
PCU	Process Control Unit
PCV	Process Control View (DCS HMI software)
PDF	Portable Document Format
PE	Potential Earth
PID	Proportional Integral Derivative
PLC	Programmable Logic Controller
PRM	Profibus Remote Master (by Schneider Electric)
PV	Process Variable (PID Control)
RFI	Request for Information
RIO	Remote I/O
RRF	Risk Reduction Factor
RSTP	Rapid Spanning Tree Protocol
RTU	Remote Terminal Unit
SAT	Site Acceptance Test
SCCR	Short Circuit Current Rating

SIS	Safety Instrumented System
SIF	Safety Instrumented Function
SIFT	System Integrated Functional Test
SIL	Safety Integrity Level
SIT	Site Integrated Test
SP	Setpoint
STEL	Short Term Exposure Limit
TLV	Threshold Limit Value
TWA	Time Weighted Average
TC	Tray Cable
TU	Termination Unit
UPS	Uninterruptible Power Supply
V	Volts
VCSEL	Vertical Cavity Surface Emitting Laser
WAN	Wide Area Network
WSTP	Winnipeg Sewage Treatment Program
VFD	Variable Frequency Drive
VM	Virtual Machine

1.4 Definitions

As-Built Documents	Drawings and other design documents that represent the final state of the project, as constructed and commissioned, and are not authenticated by a professional engineer.
Automation Room	A room primarily containing automation equipment, such as PLCs and control panels, but not typically occupied by personnel for operations functions.
Building Mechanical	All mechanical systems associated with buildings and infrastructure, but not including process mechanical systems. Ventilation associated with odour control systems, but not necessarily the odour treatment system itself, should be considered as part of the Building Mechanical system.
Codes	As defined in Section 2.1.3
Commissioning Authority	The person or firm responsible for the delivery of the commissioning process.
Contractor	The entity responsible for constructing the design. In a design-build procurement methodology, this is the design-builder.
Control Room	A room containing PCS operator workstations and other operator systems for monitoring and controlling the facility.

	Automation Design Guide	Revision: 03	Page 15 of 132
		Document Code: 612620-0013-40ER-0001	

Design Team	The entity responsible for providing the detailed design of a project. In a design-bid-bid procurement methodology, this is typically the consultant. In a design-build procurement methodology, this is the design-builder.
Electrical Room	A room this is primarily designated to contain electrical equipment, including switchgear, MCCs and panelboards.
Engineer of Record	The professional engineer ultimately responsible for the design registered in the Province of Manitoba.
Hazardous Location	An area where flammable liquids, gases, vapors or combustible dusts may exist in sufficient quantities to produce an explosion or fire.
Non-Process Area	Any area or location either within or outside of a building that is not a Process Area.
Process Area	Any area or location either within or outside of a building that contains piping, equipment, or any other asset that contains or handles a process fluid or material, including chemicals. Within a building, a single room or space cannot be divided into both a Process Area and a Non-Process Area.
Server Room	A room that is primarily designated for containing computer and networking equipment.
System Integrator	The entity responsible to design/develop, install, test and commission all aspects of a fully functional Process Control System based on the Automation Design Guide requirements and any/all additional requirements defined by contract.

 Winnipeg	Automation Design Guide	Revision: 03	Page 16 of 132
		Document Code: 612620-0013-40ER-0001	

This page is intentionally blank.

2 GENERAL

2.1 References

2.1.1 General

Where this document, codes, standards, and other referenced documents differ in content, the most stringent shall apply.

2.1.2 City of Winnipeg Standards

The following City of Winnipeg standards shall be used where applicable:

1. Water and Waste Department Identification Standard, document number 510276-0000-40ER-0002.
2. Wastewater Treatment Electrical Design Guide, document number 510276-0000-40ER-0002.
3. Tag name Identification Standard, document number 612620-0014-40ER-0001.
4. HMI Layout and Animation Plan, document number 612620-0015-40ER-0001.
5. Historical Data Retention Standard, document number 612620-0016-40ER-0001.

2.1.3 Codes and Standards

ANSI	American National Standards Institute
ASTM	American Society for Testing and Materials
ATEX	Atmospheres Explosives
CSA	Canadian Standards Association
CEC	Canadian Electrical Code
IEEE	Institute of Electrical and Electronic Engineers
IEC	International Electro-technical Commission
ISA	International Society of Automation
NFPA	National Fire Protection Association
NEMA	National Electrical Manufacturers Association
PI	PROFIBUS International
ULC	Underwriters Laboratories of Canada
WSHA	the Workplace Safety and Health Act (Manitoba)

2.1.4 Local Codes and Bylaws

The latest editions of the following codes and bylaws, together with any bulletins or addenda thereto, shall be referenced when performing automation designs for the City of Winnipeg.

1. Manitoba Electrical Code 76/2018
2. Winnipeg Electrical Bylaw 72/2022

 Winnipeg	Automation Design Guide	Revision: 03	Page 18 of 132
		Document Code: 612620-0013-40ER-0001	

2.2 Units of Measure

All drawings and documentation, including design calculations, and field instruments shall use the International System of Units (SI units). Imperial units on drawings and documentation will be provided in parenthesis after the metric unit, where requested or appropriate.

	Automation Design Guide	Revision: 03	Page 19 of 132
		Document Code: 612620-0013-40ER-0001	

3 PROCESS CONTROL SYSTEM

3.1 General

The Process Control System (PCS) at the wastewater treatment facilities provides monitoring and control of the wastewater treatment process and ancillary systems.

The original process control system installed at each wastewater treatment facility was based on an ABB/Bailey Infi90 Distributed Control System (DCS). The City has initiated a program to replace the DCS with a Process Control System (PCS) based upon distributed Programmable Logic Controllers (PLCs) along with new HMI and historian systems.

The City underwent a standardization process to standardize on the make and model of new Process control system (PCS) equipment (including PLCs, HMI software, HMI hardware, historian software), process instruments, gas detection systems, motor control equipment, and valve actuators. All new designs utilizing such components shall make use of the City's standardized components to ensure consistency in the operation and maintenance of the treatment facilities.

The following sections provide guidance on the design and implementation of new process control systems at the wastewater treatment facilities utilizing the City's standardized components.

3.2 Existing DCS

The original ABB/Bailey Infi90 DCS installations are composed of one or more Process Control Units (PCUs) in each major process area, and an HMI system utilizing ABB/Bailey Process Control View (PCV) and S+ software.

A PCU consists of one or more rack type industrial cabinets containing the DCS programmable controller, I/O modules, communication modules, power supply, and field wiring Termination Units (TUs). The processor and I/O modules are typically located in the front-half of the main cabinet, and the TUs are located in the rear-half of the same cabinet. Additional TUs may be located in adjacent cabinets as required.

A TU provides the physical connection points for discrete and analog I/O field wiring, and often contains DIP switches, relays, and other components for customizing the operation of the TU for the associated I/O module and/or field device. One TU is typically provided for each I/O module, and are individually connected together using pre-fabricated cord sets.

The City typically uses 120 Vac discrete input modules and 24 Vdc discrete output modules. Note that the TUs for the discrete output modules contain interposing relays to transition the 24 Vdc signal coming from the discrete output modules to 120 Vac signals for the field devices.

While the DCS has served the City well, the functionality and maintainability of an older system is limited and therefore the City has initiated a program to replace the DCS with a PLC based PCS.

As the existing DCS is in the process of being replaced, the Automation Design Guide does not provide details regarding DCS component upgrades, nor the means of integrating new process equipment into the DCS. However, Section 3.10.1 provides details on the replacement of a DCS PCU with a new PLC based PCS system.

3.3 Architecture Overview

A high-level overview of the upgraded process control system architecture is provided in Figure 3-1, which shall be used as the basis for design of all new PCS installations.

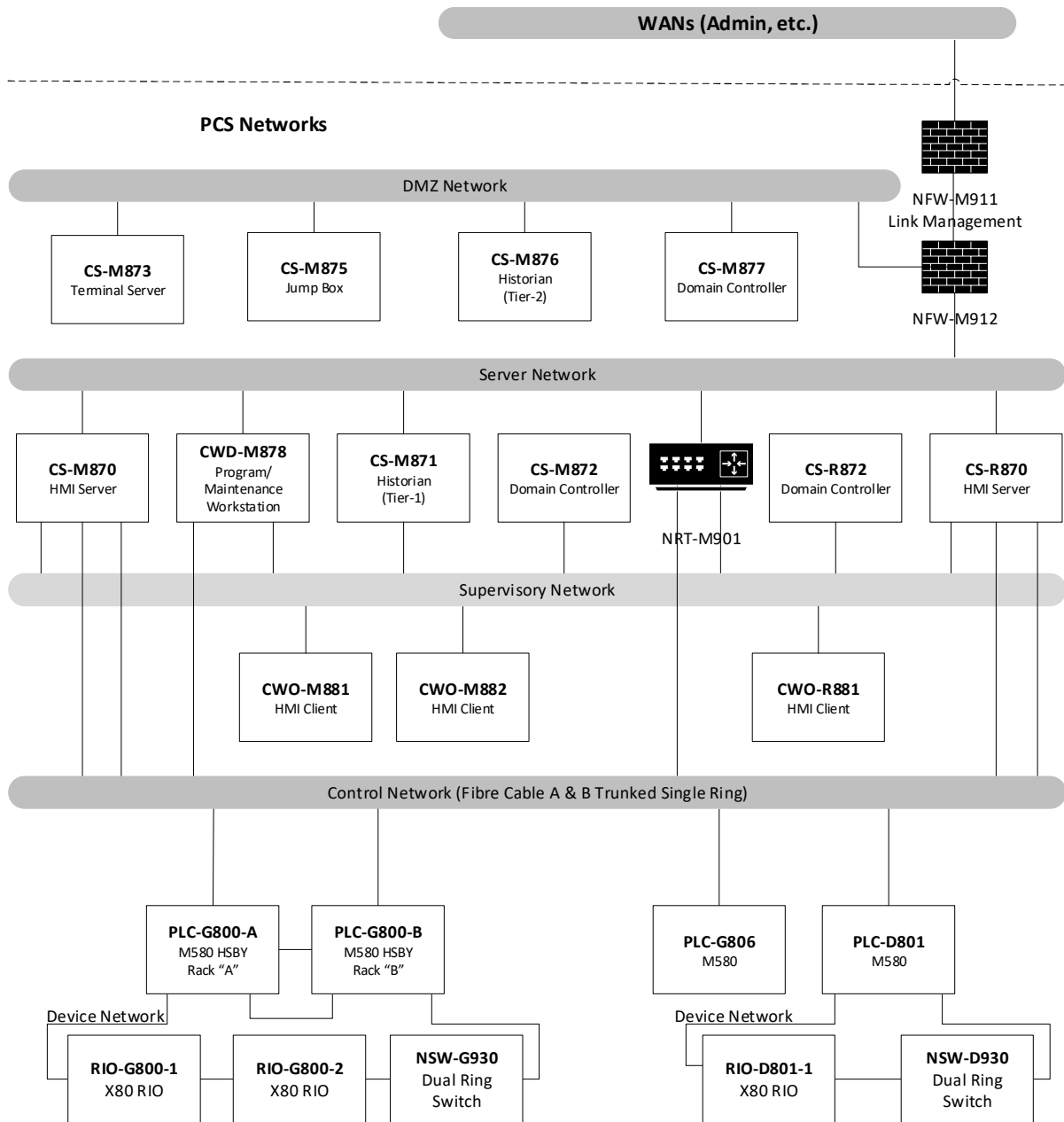

Figure 3-1: Facility PLC-based Process Control System Architecture

Notes regarding Figure 3-1:

- The figure is not comprehensive in that it does not show typical quantities of programmable controllers, remote I/O racks, HMI clients, etc., that would be installed at a wastewater treatment facility.*
- All network switches and patch panels are not shown.*
- NEWPCC equipment will have four-digit identifiers as per the Identification Standard.*
- Field equipment such as instruments, motor starters, VFDs, etc., are not shown.*

	Automation Design Guide	Revision: 03	Page 21 of 132
		Document Code: 612620-0013-40ER-0001	

5. *Refer to Section 3.4.35 for additional details on the device networks for connecting field equipment.*
6. *Device tags are for reference only*

Implementation details for the communication network, HMI system, programmable logic controllers, and field devices are provided in the following sections.

3.4 Communication Networks

3.4.1 General

The standard communication network implementation at the wastewater treatment facilities consists of three primary networks, as follows:

1. **Process Control System Network** – a multi-tier network for communication between process control system equipment including programmable controllers, HMI servers, HMI clients, historian servers, and field devices. The network is composed of a mix of Ethernet and fieldbus technologies.
2. **Administration Network** – an Ethernet network for communication between administration systems including office and laboratory computers, printers, computer servers, and the corporate WAN.
3. **Security Network** – an Ethernet network for security systems equipment including video surveillance cameras and recorders.

Only the Process Control System Network is shown in Figure 3-1, with the exception that WAN Redundant Link Management Firewall is also shown, which is part of the Administration Network. Note that the Administration Network and Security Network typically fall under the responsibility of the City's Information Technology (IT) group and therefore standard topologies for these networks are not provided.

3.4.2 Facility-Wide Fibre Backbone Ring Network

Provide a facility-wide fibre backbone ring that will act as the backbone for the new Process Control System Network. Provide a minimum of two redundant 24-strand fibre cables between major process areas. Eight of the strands in each fibre cable would be dedicated to the Process Control System Network, two strands for the Administration Network, and another two strands for Security Network. The remaining strands in the cable will be spare.

The fibre backbone ring shall span the entire facility and pass through all process areas and buildings, install fibre patch panels and networking panels with spacing to ensure that:

- Copper network wiring is not required between buildings;
- Copper networking lengths are limited to 75% of their maximum design lengths;
- At least one fibre-networking panel is located in each building for connection to the fibre ring.
- Care must be taken with the network design to not exceed the limiting distance between controllers
- Networking equipment associated with the Administration and Security Networks is the responsibility of the City's IT group, and will be physically separated at all levels from the Process Control System Network (other than sharing a common fibre cable).

	Automation Design Guide	Revision: 03	Page 22 of 132
		Document Code: 612620-0013-40ER-0001	

- Designer/ System Integrator will assign IP address based on City assignment & approval. Always confirm IP address assignment prior to implementation.

3.4.3 Process Control System Network

The Process Control System Network is segregated into multiple tiers for the sake of performance and security as follows:

1. **Demilitarized Zone (DMZ)** – a sub-network between the Administration Network and the Process Control Network for locating devices that are accessed from both of these networks. The demilitarized zone typically contains a read-only terminal server, and a jump box.
2. **Supervisory Network** – a facility-wide fibre/copper Ethernet, for communication between HMI servers, HMI clients, and portable HMI clients.
3. **Server Network** – a fibre/copper Ethernet sub-network for communication between HMI servers and historian server(s).
4. **Control Network** – a facility-wide redundant fibre/copper Ethernet sub-network for communication between HMI servers and programmable controllers, and for controller-to-controller communication.
5. **Device Networks** – multiple independent copper sub-networks within each process area for communication between the programmable controllers, remote I/O, and field devices. The network is implemented using a combination of Ethernet/IP, Modbus/TCP, and PROFIBUS.

All connections to PCS Network devices that are not included in the approved network design are strictly forbidden without explicit authorization by the City of Winnipeg. Each of these network tiers are further described in the following sections.

1. Demilitarized Zone (DMZ)

The Demilitarized Zone (DMZ) is a sub-network that contains computer servers and other networked equipment that will be accessed from both the Administration Network and the Process Control System Network. The DMZ would typically contain a Domain controller, a terminal server for read-only access to the HMI system, and a jump box for managing network access.

Firewalls are used to control access in and out of the DMZ. A firewall shall be installed between the Administration Network and the DMZ. It is preferable to keep WSTP devices consistent. The firewall (NFW M912), Jump box (CS-M875), and WAN redundant link firewall in Figure 3-1 will be installed and maintained by City Wastewater Services.

The DMZ network shall be located in the Administration Building of a wastewater treatment facility, and does not typically extend to other plant areas. For this reason, the DMZ is implemented using CAT6 cabling in a star topology. Devices in the DMZ operate at a minimum of 1 Gbps network speed as required.

Install a dedicated DMZ network switch for connection of the devices in the DMZ.

2. Supervisory Network

The Supervisory Network is a facility-wide sub-network used for communication between the HMI clients and HMI terminal servers, if applicable.

Implement the Supervisory Network using a combination of fibre and CAT6 Ethernet cabling in a ring/star topology. Use fibre cabling in a ring topology between major process areas and fibre or CAT6

	Automation Design Guide	Revision: 03	Page 23 of 132
		Document Code: 612620-0013-40ER-0001	

cabling in a ring topology to feed minor process areas from adjacent major process areas. Connect HMI clients and HMI servers to the network using CAT6 cabling in a star topology.

Install a dedicated network switch for the Supervisory Network inside a networking panel in each major process area. The network switch shall be equipped with both fibre and copper ports for connection to the supervisory fibre ring and copper-connected devices.

The main ring shall operate at 1 Gbps network speed. The HMI servers shall operate at a minimum 1 Gbps, and the HMI clients that are connected via CAT6 cabling shall operate at a minimum of 1 Gbps.

3. Server Network

The Server Network is an Ethernet sub-network used for communication between computer servers including the HMI servers, historian server, and domain controller. Programming/maintenance workstations are also connected to the Server Network to facilitate server administration.

Redundant computer servers (e.g. the HMI Servers) are to be located in two separate areas of the facility; therefore, a fibre cable is used to connect the two areas where the computers are located.

The fibre cable for the Server Network would typically be a separate fibre cable from that of the main fibre ring, but two strands in the main fibre ring may be used for the Server Network if it is practical to do so (i.e. if the routing is similar).

Provide dedicated network switches at each end of the server network for connection of the servers and programming/maintenance workstations.

The server network and the computer servers shall operate at a minimum of 1 Gbps network speed.

4. Control Network

The control network is a redundant facility-wide Ethernet sub-network for communication between the HMI servers and programmable logic controllers, and for controller-to-controller communication. The network is to be implemented using a combination of CAT6 and fibre media in a ring and star topology. Fibre cabling in a ring topology is used between major process areas, and CAT6 cabling is used to feed minor process areas from adjacent major process areas. The ring consists of backbone switches connected with trunk fibre strands from parallel fibre cables. Connect the HMI servers and programmable logic controllers to the network using CAT6 cabling in a star topology.

Provide dedicated redundant network switches in major process areas for each control network. The network switches are connected in serial and shall be equipped with both fibre and copper ports for connection to the facility fibre ring and the copper-connected devices. Control network switches shall be located in networking panels.

Programming/maintenance workstations are also connected to the Control Network for programming and maintenance of the PLCs. These workstations will require two network adapters for connection to the Control Networks, in addition to the network adapter for the server network.

The control network rings shall operate at a minimum of 2 Gbps. The HMI servers and engineering workstations shall operate at a minimum of 1 Gbps, and the PLCs shall operate at a minimum of 100 Mbps.

5. Device Networks

Install one or more independent device networks in each process area to allow for data exchange between programmable controllers and field equipment.

Device networks are implemented using a combination of Ethernet and fieldbus technologies including Ethernet/IP, Modbus/TCP, and PROFIBUS DP/PA. The network provides high-speed connectivity to

	Automation Design Guide	Revision: 03	Page 24 of 132
		Document Code: 612620-0013-40ER-0001	

field devices such as remote I/O racks, VFDs, and MCCs, and PROFIBUS devices such as instruments and valve actuators.

Ethernet-based field devices shall be connected using a ring topology to the greatest extent practicable. All field devices in an Ethernet ring must support the Rapid Spanning Tree Protocol (RSTP). Ethernet-based field devices that do not support the ring topology can be connected to an in-rack Ethernet module or to a network switch in the main ring using a star or daisy-chain topology, rather than a ring topology. Products should align with what is currently being used at the other Wastewater treatment plants and approved by the City.

Remote I/O racks on the network are considered RIO devices, and all other Ethernet devices such as MCC intelligent overloads, VFDs, and soft-starters are considered DIO (Distributed I/O) devices. RIO devices and DIO devices cannot reside within the same Ethernet ring. DIO devices must be connected in a “DIO sub-ring” or in a “DIO cloud” off the main ring, or placed in an independent network from the RIO devices (e.g. by connecting the DIO devices directly to a DIO Ethernet module that is not interlinked with an RIO Ethernet module). A DIO cloud is a collection of DIO devices connected using a star or daisy-chain topology rather than a ring topology. Schneider Electric manufactures specific “Dual Ring Switches” (DRSs) to facilitate dual ring network architectures and for connection of DIO devices to the RIO ring. Part numbers for Dual Ring Switches are provided in Table 3-1-2.

Note that a maximum of 31 RIO drops plus 64 DIO devices are supported in a single network (as of the time of writing).

Ethernet networks should be designed such that no more than ten (10) Ethernet devices are connected to a single point of failure (e.g. a network switch). This can be achieved by providing additional PLC networking modules, network switches, or connecting the devices in a ring topology to eliminate the single point of failure.

Where equipment redundancy (e.g. Duty/Duty or Duty/Assist) is provided in the field, the associated networked devices (e.g. motor controllers) should be connected to separate network switches to prevent both pieces of equipment from being taken out of service upon a single network device failure.

Minimize the number of Ethernet network switches in process networks by connecting Ethernet cabling directly to field devices where practicable. Network switches are a point of failure; therefore, network switches shall only be installed within device networks if absolutely required (e.g. to support a DIO sub-ring or DIO cloud).

A PROFIBUS network may be added to a device network if communication to PROFIBUS devices is required. It is recommended to use PROFIBUS instruments as opposed to hard-wired 4-20 mA instruments due to the reduced cabling and availability of additional diagnostics information. The PROFIBUS network will be created by use of PRM gateway or PROFIBUS DP modules as required by design.

PROFIBUS DP networks shall be designed for operation at 1.5 Mbps and operated at 500 kbps. PROFIBUS PA networks shall be designed for and operated at 31.25 kbps.

Each PROFIBUS DP and PA segment shall have at least one point of connection for a programming device or bus analyzer. For Profibus DP segments, this is typically provided by a 9-pin D-shell connector that has a PG socket. For Profibus PA segments, a set of feed-through terminals with parallel points of connection may be provided. Include multi-master so live circuits can be tested and a device can be tested without disconnecting the circuit.

Ensure that all PROFIBUS installations facilitate removal of the field devices from the network without adversely affecting the process. If equipment is daisy-chained on the network, removal of one device from the mid-point of the network may cause all downstream devices, or the entire network segment, to stop working. Some equipment, such as Rotork valve actuators, have provisions for isolating the equipment from the network without affecting the network. Where such provisions are not provided by the equipment vendor and disconnection of a particular device from the network will negatively affect the process, and then external provisions are typically required. One method is to provide multi-channel

	Automation Design Guide	Revision: 03	Page 25 of 132
		Document Code: 612620-0013-40ER-0001	

repeaters or segment protectors and segregate the devices to independent network segments. Another method is to provide external terminations on the network. These methods may be used independently, or in conjunction, as required.

If multi-channel repeaters or segment protectors are used then it is best to group devices that are associated with one control loop on a common segment. That way, it won't matter if removal of a device takes down the network segment since failure of the device would have prevented the control loop from operating in the first place. Where equipment redundancy is provided in the field, group all devices associated with the duty equipment on one segment and all instruments associated with the standby equipment on another segment.

If a field device (e.g. instrument or valve actuator) is providing the end-of-line termination, removal of the device will generally take down the network, since the termination will be lost. For this reason, it is often required to install external end-of-line terminations, even if the field devices are capable of terminating the network. As previously indicated, PROFIBUS DP networks require an active termination, so if an external terminator is used it will typically require 24 Vdc power to it. For PROFIBUS PA networks, the terminating capacitor and resistor could be installed in a small enclosure at the end of the network.

PROFIBUS repeaters often incorporate automatic termination at the "beginning" of the network, so only a terminator and the "end" of the network is required if they are used.

When designing PROFIBUS networks, follow all design and implementation rules indicated by PROFIBUS International with respect to network speed, cable lengths, installation of equipotential bonding conductors, cable routing, and terminations.

Use of insulation displacement connectors on PROFIBUS networks should generally be avoided as their use in practice has shown that they are not reusable. After disconnecting an insulation displacement connector from the cabling, they typically cannot be properly reconnected due to malformation of the contacts within connector.

PROFIBUS field devices (instruments, valve actuators, etc.) shall be assigned an address in the range of 2 to 125. Address 0 is reserved for the Class 2 master (configuration and diagnostics tool), and address 1 is reserved for the Class 1 master (the Schneider Electric PRM module or PROFIBUS DP module). Address 126 is the default address used for new devices on the network, so it should not be assigned to a device, otherwise an address conflict may arise when adding a new device to the network. Address 127 is the broadcast address, so this address shall not be assigned to any device.

For connection of HART devices, Schneider Electric produces in-rack HART modules that are available for the X80 platform. Where HART modules are used, they must be installed in an appropriate slot within a BME Ethernet backplane. HART modules must be used in conjunction with an M580 processor. If HART modules are installed in a remote rack, then the BME XBP and BME CRA drop adapters must be used.

If wireless instruments are required, install an appropriate gateway on the associated device network to facilitate communication with the instruments. Wireless instruments shall not be connected to the Control Networks. Refer to Section 16.3.3 for additional information on use and selection of wireless instruments.

3.4.4 Network Routing

Network routing between the control networks and the device networks should be provided so that the programming/maintenance workstations are able to connect to devices in the device networks.

Routing functionality can be provided by the Ethernet Control Network Head Adapter, catalog number BMENOC0321. Install a Control Network Head Adapter module in each HSBY rack where it is required to route down to an associated device network and one on a standalone PLC where routing to the device network is required. Note that static routes will need to be configured on the programming/maintenance workstations, which is described in the Schneider Electric documentation.

Where routing capability is not provided to a particular device network, this would require maintenance personnel would bring a laptop into the field and connect to devices or the device network directly, and should only be utilized for special cases where limited, infrequently maintained devices are on the network.

A routing device is also used to facilitate communication between the Server, Supervisory and Control networks when an equipment has no direct network interface to a specific network. The communication from/to a specific network will primarily occur via the network interface directly connected. The communications between HMI Clients and Device Network are through the routing device as there is no direct network interface available.

The router (NRT-M901) in Figure 3-1 will be installed and maintained by City Wastewater Services.

3.4.5 Network Equipment and Cabling

Table 3-1-2 provides standard catalog numbers for typical Schneider Electric network hardware used in the Process Control System Network.

Table 3-1-2: Standardized Networking Components

Purpose	Port Specifications	Model Number
Dual Ring Switch in Device Network	8 x 100Base-TX	MCSESM083F23F1
PROFIBUS Remote Master	2 x 100Base-TX	TCSEGPA23F14F

Notes;

1. For all networks above the device network layer, the make/model of the Dual Ring Switch should be consistent with what is being used throughout the wastewater treatment facilities.

Use laser-optimized 50/125 µm, multimode, OM3 cable for all new fibre installations. All fibre network switches shall use VCSEL transmitters. For distances over 750m, alternatives will be considered. These alternatives must be discussed and approved by the City.

Cabling associated with ring networks shall be routed such that no two points of the ring are adjacent to each-another within the same duct or cable-tray.

Where CAT6 cable is routed near sources of electromagnetic noise, such as in MCCs, VFD cabinets, or near power cabling, use shielded CAT6 cable and ground the shield at one end. Shielded RJ45 connectors that are plugged into appropriately grounded RJ45 ports may be used for grounding the cable shield.

CAT6 cable located within equipment containing 600V shall have an insulation rating of 600V.

CAT6 cabling entering or leaving a networking panel shall be terminated on patch panels. Do not connect fibre or CAT6 field cables directly to the network switches within network panels; only patch cables are permitted to be connected to network switches in networking panels. It is generally preferred to connect CAT6 cabling directly to equipment in the field, where patch panels are not provided.

For CAT6 cabling operated at 100/1000 Mbps network speed, the maximum allowable length is 100 meters. However, to allow for cabling between patch panels and network switches, and between network jacks and end devices, permanent cabling shall be limited to 75% of the maximum allowable design length. This allows for the installation of patch cables and incorporates some level of contingency.

	Automation Design Guide	Revision: 03	Page 27 of 132
		Document Code: 612620-0013-40ER-0001	

3.4.6 Wireless Networking

Wi-Fi access points should be provided throughout wastewater treatment facilities in electrical and control rooms and in the field where useful. Access points should be mounted on the ceiling for better coverage if possible. Provide a wireless controller/switch combination to accommodate the number of access points being installed. Make and model numbers to be approved by the City for compatibility and consistency.

Wi-Fi access points shall be connected to the facility Administration Network, and be fully managed by the City's Information Technology (IT) group.

3.5 HMI and Historian Server Systems

3.5.1 General

When a wastewater treatment facility is upgraded with a PLC based control system, provide new HMI and historian server systems based on the City's standardized goods contracts.

The following sections apply to new HMI system installations at wastewater treatment facilities.

All redundant servers at each facility to be located in separate process areas. The primary servers shall be located in the main process control system server room (typically within the Administration Building), and the secondary servers shall be located inside an automation room or server room in a different major process area. The purpose of locating the servers in different areas is to prevent both servers from being damaged in the event of a fire or similar catastrophic event that is localized to the process control system server room. The automation room or server room shall be located in non-floodable areas that don't have any pipes with liquids above the area.

3.5.2 HMI Servers

Each HMI server consists of multiple individual software services that operate on a common hardware server. Such services include but not limited to the I/O server, alarms server, trends server, and report server. The primary purpose of the HMI servers is to communicate with the PLCs to obtain tag data and make the data available to HMI clients. Servers should be selected by latest makes and models used in other Wastewater treatment plants and by any applicable City IT standards.

HMI servers should include a "lights out management (LOM)" server management, the same as the HP "Integrated Lights-Out" or iLO. Install HMI server software and the facility HMI application on each HMI server.

Implement hardware virtualization on the HMI server computers with VMWare ESXi. Refer to Section 3.8 for additional information on server virtualization.

Each HMI server shall be connected via Ethernet to the Primary and Secondary Control Networks, as well as the server network, as shown in Figure 3-1. Each HMI server therefore requires a minimum of three Ethernet adapters. HMI servers will use teamed NICs for redundant connection to Control Network.

3.5.3 HMI Clients

HMI clients should be directly connected to the HMI servers via the Supervisory Network and should directly communicate with the HMI servers which are connected to Server network. The HMI clients will not use a thin client technology which also known as Terminal Services.

	Automation Design Guide	Revision: 03	Page 28 of 132
		Document Code: 612620-0013-40ER-0001	

Configure HMI clients to automatically login to Windows using a user account specified by the City and open the HMI application upon boot-up.

Install Aveva Historian Client and configure read only access to tier-1 historian server with autologin windows user account.

HMI Clients should be configured to connect to an HMI Server based on the preferred list in automatic mode. In case of the first choice HMI Server is not available, the client should connect to the second choice HMI Sever. In manual mode, the HMI Client should be connected to a manually designated HMI Server.

If HMI clients are installed in occupied rooms or in an area with dust or environmental concerns, fan less models shall be used.

3.5.4 DMZ HMI Terminal Servers

An HMI terminal server shall be provided in the DMZ network for access to the HMI from the office computers on the Administration Network, from mobile devices such as smart-phones and tablets, and from other facilities (e.g. viewing SEWPCC from NEWPCC). The HMI runtime software shall be configured read-only to prevent unauthorized control of the HMI system.

The HMI client shall automatically start on user login. Install Aveva Historian Client and configure read only access to tier-2 historian server for above users.

Implement hardware virtualization on the HMI terminal server computers using VMWare ESXi. Refer to Section 3.8 for additional information on server virtualization

Terminal server should be configured to connect to HMI Server based on the preferred list in automatic mode. In case of the first choice HMI Server is not available, the terminal server should automatically connect to the second choice HMI Sever, so on and so forth. In manual mode, the terminal server should be connected to a manually designated HMI Server.

3.5.5 Historian Server

Install the Historian software as defined in Standardized goods on the historian server. The number of points included should be sized for the current project and for all upcoming projects that are known at the time.

Provide a tier-1 historian server at each facility. Only one tier-1 historian server is required as the HMI servers are able to buffer data in the event that the historian server is out of service. The facility historian server shall be connected via Ethernet to the Server and Supervisory networks, as shown in Figure 3-1.

Locate the tier-1 historian server in the main process control system server room (typically within the Administration Building at the facility).

A centralized tier-2 historian may be installed on NEWPCC DMZ network or another location.

The tier-1 historian sends its replicated data to a tier-2 historian.

Implement hardware virtualization on the historian server computer with VMWare ESXi. Refer to Section 3.8 for additional information on server virtualization.

The period of data retention on the historian system shall be consistent with the Historical Data Retention Standard, document 612620-0016-40ER-0001. Ensure the hard drives are sized to meet the data retention requirements. Designer/ System Integrator to provide details of data retention requirements including capacity of storage and expected duration of retention until storage is at capacity. A strategy for managing data archival and database cleanup shall be implemented. This shall be developed in consultation with City staff.

	Automation Design Guide	Revision: 03	Page 29 of 132
		Document Code: 612620-0013-40ER-0001	

3.6 Modification of HMI Systems

All HMI system configurations and HMI applications shall be fully accessible and editable by the City of Winnipeg. The City shall be granted access upon start of project and will only be allowed to edit upon completion of project or handed over area. HMI hardware or software applications that are password protected and as a result made inaccessible for modification by the City for any reason, will not be accepted under any circumstance. This applies to HMIs used for any application, including process and HVAC applications.

3.7 Domain Controller

Provide two redundant domain controllers at each facility for security authentication (user login, permissions, etc.) on the supervisory network. Use domain-based security on all computers associated with the process control system, which includes the HMI servers, historian, HMI clients, programming/maintenance workstations, and laptops as applicable.

Domain security needs to be developed in consultation with the City. Scada user rights and domain user rights should be integrated. A single sign on is preferred.

The two domain controllers shall be located at two different process buildings.

One separate domain controller on DMZ is for security authentication on DMZ network.

3.8 Server Virtualization

Computers hosting process control system server software should use virtual machine (VM) technology to facilitate rapid recovery following a hardware or software failure. Use of server virtualization is not mandatory, but is recommended. Note that omission of server virtualization must be reviewed and approved by the City before it is omitted.

Use of server virtualization software included in RFP-XXX. Currently Schneider Electric has verified compatibility of their HMI software with VMWare ESXi. An appropriate level and version of licensing must be provided after discussion with the City.

VMWare ESXi is a Type 1 hypervisor, also known as a bare metal hypervisor, which means the server virtualization software is installed directly on a bare computer, not within an operating system such as Microsoft Windows. The server virtualization software then mimics the existence of virtual hardware, which an instance of Microsoft Windows is installed upon. Since the hardware seen by the operating system (Microsoft Windows) is virtual hardware, it is possible to replace the physical computer with a new computer and reinstate the software without having to repair the operating system installation or update the drivers. The benefit of using a Type 1 hypervisor as opposed to a Type 2 hypervisor is that it is not required to install an operating system prior to installing the server virtualization software.

Snapshots of the VM's disk file will be taken by the City at periodic intervals and will be used to restore a server after a hardware or software failure. This will be achievable when City has full access to the servers at the beginning of project.

3.9 Programming/Maintenance Workstations

Provide programming/maintenance workstations to facilitate remote programming and management of process control system equipment including the PLCs, HMI servers, historian, motor control equipment, and field instruments. A typical facility would require a minimum two (2) programming/maintenance workstations.

	Automation Design Guide	Revision: 03	Page 30 of 132
		Document Code: 612620-0013-40ER-0001	

Install the relevant software applications on the programming/maintenance workstations, including but not limited to:

1. Schneider Electric Aveva Plant SCADA development software,
2. Schneider Electric Vijeo Designer touchscreen HMI software,
3. Schneider Electric Eco structure Control Expertly programming software,
4. Schneider Electric Aveva Historian client, Operations Control Management Console
5. Schneider Electric SoMove motor control equipment configuration software, and
6. Adobe PDF reader or equivalent

Note: Upon transfer of workstation, System Integrator is to ensure software is of the latest version being used.

Install the following software applications on the programming/maintenance workstations:

1. Microsoft Office
2. Adobe or equivalent
3. City of Winnipeg's current Virus protection software

Prior to securing any software confirm with City Project Management to ensure licenses have not been purchased already.

Locate the programming/maintenance workstations as directed by the City.

Connect the programming/maintenance workstations to control network, supervisory network and the server network. As such, each programming/maintenance workstation requires three network adapters.

3.10 Programmable Logic Controllers

The City has standardized on the use of Schneider Electric Modicon PLCs for all new PLC installations at the wastewater treatment facilities through RFP 756-2013. All processors shall be of the M580 series unless otherwise approved by the City. The exact model and configuration of the PLC is dependent on its application, but will generally fall into one of the four following categories:

1. **PLC to Replace an Existing DCS PCU** – a high-end redundant PLC system installed within an existing DCS cabinet or in an adjacent cabinet that is used for control of existing equipment via the existing field wiring.
2. **PLC for New Process Equipment or Independent Critical Equipment** – a high-end redundant PLC system that is used for control of new wastewater treatment process equipment or for control of independent critical equipment.
3. **PLC for a Minor Process Train or Auxiliary Equipment** – a non-redundant PLC for control of non-critical equipment.
4. **Packaged PLC from Equipment Vendor** – a non-redundant PLC supplied with packaged equipment having non-customizable control.

Each of these applications are described further in the following sections.

	Automation Design Guide	Revision: 03	Page 31 of 132
		Document Code: 612620-0013-40ER-0001	

3.10.1 PLC to Replace an Existing DCS PCU

New PLC installations that replace existing DCS PCUs shall use Schneider Electric Modicon M580 controllers in a hot-standby (HSBY) configuration with X80 series Remote I/O (RIO).

The M580 HSBY configuration requires that each processor be installed in an independent chassis. Each HSBY rack (chassis and modules) must be identical, and must only contain a power supply module, processor module, and communication modules. I/O modules are located in separate RIO racks. PLCs must be powered by a UPS circuit or have local UPS backup.

Table 3-3-3 and Table 3- in Section 3.11 list the standard part numbers for the M580 HSBY racks and X80 remote I/O racks.

RIO racks are connected to the main racks via a fault-tolerant Ethernet RIO ring network. Distributed I/O (DIO) devices such as intelligent MCCs, VFDs, and soft-starters connect to a Schneider Electric Dual-Ring Switch (DRS) off the main RIO ring. DIO devices can be connected in a ring topology (if the devices support ring networks), or a star topology.

A sample architecture diagram of a hot-standby system with remote I/O, VFDs, and smart overloads is shown in Figure 3-2 in Section 3.12.

It is recommended to re-use the existing Termination Units (TUs) in the DCS cabinets to facilitate the reuse of the existing field wiring. This will significantly reduce downtime and costs associated with the new PLC installation. The TUs can be connected to the new PLC system using custom cord sets that are available from Schneider Electric Winnipeg Inc.

If mounting the new PLC hardware in an existing DCS cabinet, the installation may be expedited by pre-mounting and pre-wiring all the new components onto one or more back-panels that can be installed into the DCS cabinet as an assembly.

In some instances, it may be more expedient to install the new PLC hardware in separate independent control cabinets. This will allow parallel operation of the PLC and DCS during the integration process. The new I/O would likely be part of a separate control panel installation if insufficient room exists in the existing DCS termination cabinets.

Prior to decommissioning any DCS PCU, coordinate with the City to have them back-up the DCS run-time application.

Do not damage the DCS PCU and other components in the removal process as they will be turned over to City personnel.

Minimize interruptions to the process and coordinate activities with plant Operations. Each outage must be scheduled and approved by the City prior to commencement of the work.

The existing DCS implementation uses 120 Vac discrete input modules and 24 Vdc discrete output modules. The signals from the discrete output modules drive interposing relays on the termination units to change the 24 Vdc signals from the output modules to voltage free contacts. In general, these contacts are field powered by 120 Vac. For the new PLC system, use 120 Vac discrete input modules and 24 Vdc discrete output modules to ensure compatibility with the existing TUs and field devices. For new I/O that was not previously connected to the DCS, use 24 Vdc input and 24 Vdc output modules. New I/O will require the installation of new terminals for termination of the field and I/O module wiring, along with the appropriate Schneider Electric preformed cord set (e.g. BMX FCW 303 for the BMX DDI 3202 K input module).

3.10.2 PLCs for New Wastewater Treatment Process Equipment or Independent Critical Equipment

	Automation Design Guide	Revision: 03	Page 32 of 132
		Document Code: 612620-0013-40ER-0001	

New PLC systems for control and monitoring of new wastewater treatment process equipment or independent critical equipment shall use Schneider Electric Modicon M580 controllers in a hot-standby (HSBY) configuration with X80 series Remote I/O (RIO).

The M580 HSBY configuration requires that each processor be installed in an independent chassis. Each rack (chassis and modules) must be identical, and must only contain a power supply module, processor module, and communication modules. I/O modules are located in separate RIO racks. PLCs must be powered by a UPS circuit or have local UPS backup.

Table 3-3-3 and Table 3- in Section 3.11 list the standard part numbers for the redundant M580 racks and X80 remote I/O racks.

RIO racks are connected to the main racks via a fault-tolerant Ethernet RIO ring network. Distributed I/O (DIO) devices such as intelligent MCCs, VFDs, and soft-starters connect to a Schneider Electric Dual-Ring Switch (DRS) off the main RIO ring. DIO devices can be connected in a ring topology (if the devices support ring networks), or a star topology.

A sample architecture diagram of a hot-standby system with remote I/O, VFDs, and smart overloads is shown in Figure 3-2 in Section 3.12.

New control panels associated with wastewater treatment process equipment should be located in dedicated control/automation rooms, or electrical rooms. The control panels should be located at an elevation such that they are not subject to potential flooding. Additionally, the control panels should not be located below grade or below any piping that may be subject to leaks of any kind.

The 24 Vdc power supplies associated with each control panel should be located in a separate "Power Supply Panel".

Network switches and gateways should be located in dedicated "Networking Panels" rather than inside the control panel, but there are exceptions and in some cases installation of a network switch in a control panel may be appropriate. Networking panels should be provided in each major process area for housing the fibre switches.

3.10.3 PLCs for a Minor Process Train or Auxiliary Equipment

PLC systems for minor process trains or auxiliary equipment are not required to use redundant processors because the criticality of the equipment is low, unless failure of the minor system will in turn directly prevent another critical system from running. For non-redundant applications, use a Modicon M580 processor. I/O modules are typically located in the same chassis as the processor, but may be in a remote I/O rack if required. PLCs must be powered by a UPS circuit or have local UPS backup.

Where remote I/O (RIO) racks are required, connect them to the main rack using a fault tolerant Ethernet RIO ring network. DIO devices, such as MCCs and VFDs, may be connected to a Dual Ring Switch (DRS) as a DIO sub-ring or DIO cloud, to the service port of the processor as a DIO cloud, or to an Ethernet module as a DIO cloud.

Instruments may be connected to the PLC via hard-wired cabling, but use of PROFIBUS is encouraged. Hard-wired instruments are typical for most HVAC applications, as PROFIBUS instruments are typically higher cost.

Sample architecture diagrams of mid-grade PLC systems are shown in Figure 3-3 and Figure 3- in Section 3.12. Figure 3-3 illustrates a single PLC rack that is connected to the Control Network via one network switch, which uses local I/O. Figure 3- illustrates a slightly more critical application, which makes use of an M580 processor that connects to the Control Networks via two network switches, and uses remote I/O.

	Automation Design Guide	Revision: 03	Page 33 of 132
		Document Code: 612620-0013-40ER-0001	

3.10.4 Packaged PLC from Equipment Vendor

Where packaged PLC systems are permitted in accordance with Section 6.0 of this Design Guide the following shall apply:

Packaged PLC systems from equipment vendors may come in a variety of implementations with various brands of hardware if not specified. If possible, specify the packaged system should be based on a Schneider Electric Modicon M580 PLC, which will allow for straightforward integration with the plant process control system. PLCs must be powered by a UPS circuit or have local UPS backup.

If the vendor is unable to provide a Schneider Electric Modicon PLC, ensure that their PLC system incorporates a Modbus/TCP interface so that the City's Process Control System (PCS) can communicate with it. If a third-party product is required for the Modbus/TCP interface, the preference is to use an in-rack solution as opposed to an out-of-rack (e.g. DIN rail mounted) solution.

Regarding the program within the Vendor supplied Packaged Equipment the preferred approach is to have the vendor program the PLC, based on the City's standard function block classes and consistent with the PCS programming for the entire site. If the vendor is unable or unwilling to program the PLC based on the City's standards, then the Vendor shall provide a detailed control narrative with a detailed functional requirements and communications specifications. These would be issued to the systems integrator for programming the PLC. Failing this, the vendor should, at minimum provide a control narrative, such that the design engineer is able to develop the functional requirements specification, which would be issued to the systems integrator or the City for programming.

Due to warranty issues, some vendors may not approve that another party program the PLC supplied by the vendor. If the vendor requires that they program the PLC, have the vendor supply a PLC interface map so that the process control system PLCs and HMI system can interface with the vendor PLC. Refer to Section 22.3.4.4 for further information on Interface Maps. Request that the vendor supply a copy of the PLC program to the City and that the program not be locked or password protected. Software applications that are password protected and as a result made inaccessible for modification by the City for any reason, will not be accepted under any circumstance.

It is desired that all integration and configuration software and hardware tools and documentation are provided to the City for packaged equipment with intelligent controls, with password access to the levels and registers used by manufacturer service technicians.

3.11 Standardized PLC Hardware

This section provides standard Schneider Electric part numbers for PLC system hardware, including processors, I/O modules, backplanes, power supply modules, and ancillary components.

Additional products, beyond those listed below, may be used in the design if required.

Schneider Electric also has "harsh environment" versions of many of their products, which may be used in corrosive or damp locations. Harsh environment versions have a catalog number ending in "H" or "C".

Standard part numbers for M580 hot-standby racks are listed in Table 3-3-33-4. Standard part numbers for X80 remote I/O racks are listed in Table 3-8.

Table 3-3-3: M580 Hot-Standby Racks

Description	Catalog Number	Notes
Chassis, Ethernet Backplane	BMEXBP●●00	
Power Supply Module, 24 Vdc	BMX CPS 3020	
Power Supply Module, 120 Vac	BMX CPS 3500	
Processor	BME H58 ●●●●	See Note 1 below
Ethernet Communication Module	BME NOC 0311	
Ethernet Control Network Head Adaptor	BME NOC 0321	Integrated router
Empty Slot Filler	BMX XEM 010	

Notes:

1. *A BME H58 6040 would typically be used for DCS replacement.*

Table 3-5: X80 Remote I/O Racks

Description	Catalog Number	Notes
Chassis	BMX XBP ●●00	X-Bus Backplane
	BME XBP ●●00	X-Bus + Ethernet Backplane
Power Supply Module, 24 Vdc	BMX CPS 2010	
Power Supply Module, 120 Vac	BMX CPS 2000	
X80 Ethernet Drop Adapter	BMX CRA 312 10	Use with BMX I/O modules only
	BME CRA 312 10	Use with BME or BMX I/O modules
Discrete Input Module, 16 channel, 120 Vac	BMX DAI 1604	Use for existing I/O
Discrete Input Module, 32 channel, 24 Vdc	BMX DDI 3202 K	Use for new I/O
Discrete Output Module, 16 channel, 24 Vdc	BMX DDO 1602	
Analog Input Module, 8 channel, Non-Isolated	BMX AMI 0800	
Analog Input Module, 8 channel, Isolated	BMX AMI 0810	
HART Analog Input Module, 8 channel, Isolated	BME AHI 0812	Requires BME Backplane
Analog Output Module, 4 channel, Isolated	BMX AMO 0410	
Analog Output Module, 8 channel, Non-Isolated	BMX AMO 0802	
HART Analog Output Module, 4 channel, Isolated	BME AHO 0412	Requires BME Backplane
Empty Slot Filler	BMX XEM 010	As required
Rack Extension Kit	BMX XBE 2005	As required

Notes:

1. Part numbers starting with “BMX” can be installed into “BME” backplanes.
2. On some “BME” backplanes, only specific slot numbers on the backplane support “BME” modules. Refer to Schneider Electric documentation.

3.12 Standard Architectures

Standard architectures are shown in the following figures to illustrate the method for connecting process control system equipment using the City's preferred methods.

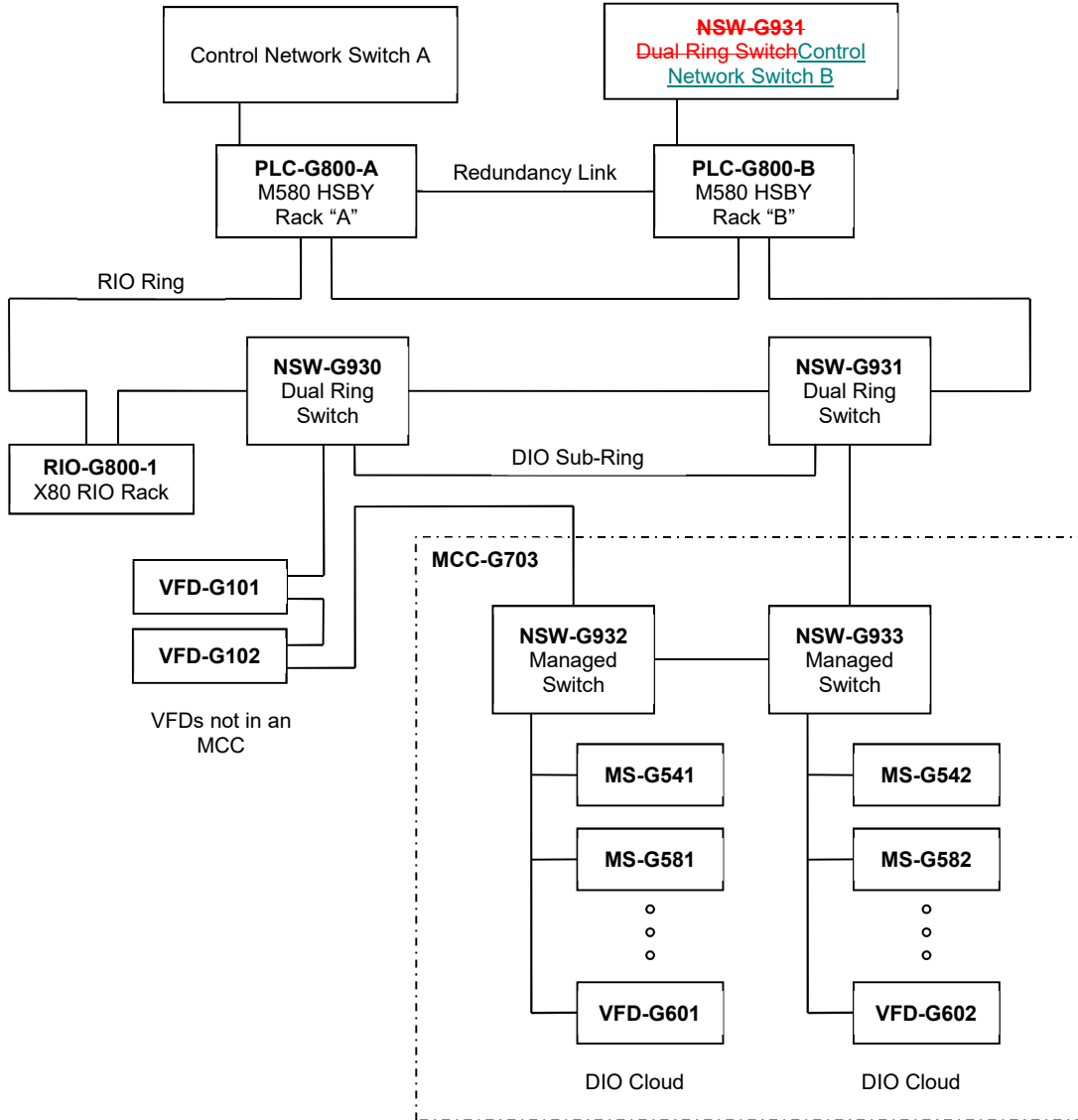

Figure 3-2: M580 Hot-Standby Architecture

Notes:

1. All I/O modules are located in separate remote I/O (RIO) racks.
2. Where process equipment redundancy is provided, the associated motor controllers should be connected to separate network switches to improve availability. In this figure, the starters in the MCC are divided to separate switches, but could also be placed in separate MCCs.
3. The DIO sub-ring for the VFDs and MCC is shown connected to two dual ring switches to improve reliability.

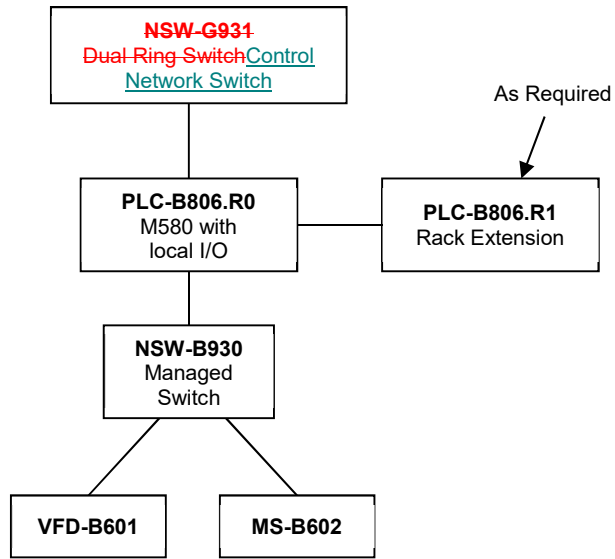

Figure 3-3: Single M580 PLC System Architecture with Local I/O

Notes:

1. *Non-redundant PLCs typically connect to one control network via the processor service port or an in-rack Ethernet module. An additional in-rack Ethernet module may be installed if connection to the Secondary Control Network is required.*
2. *Instruments are typically hardwired to in-rack I/O modules.*

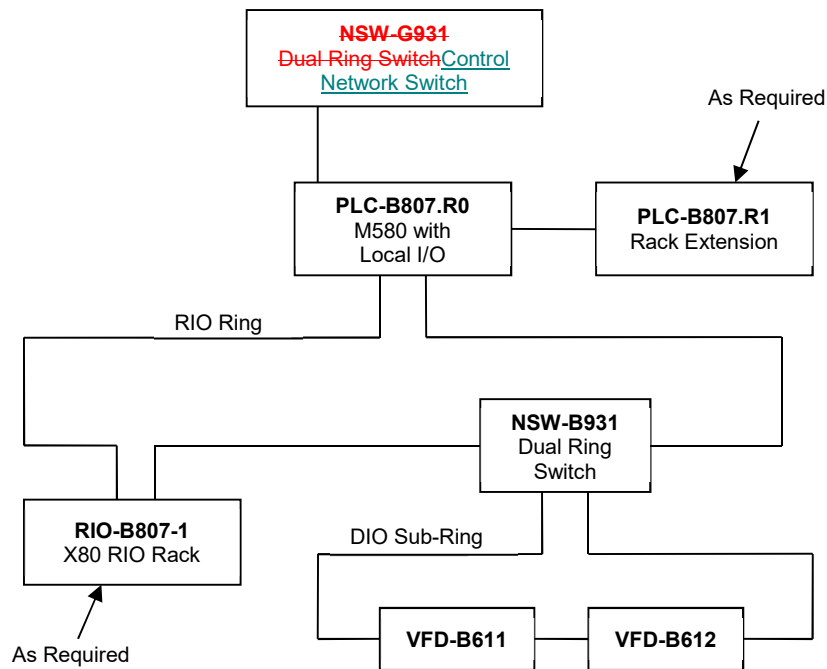

Figure 3-4: Standalone PLC System Architecture with M580 Processor

Notes:

1. Non-redundant PLCs connect to one or both control networks via the processor service port and/or in-rack Ethernet modules.
2. The M580 processor may use in-rack I/O or Remote I/O (RIO).
3. Current M580 processor model numbers are BMEP82020 for non-redundant with no RIO racks and BMEP86040 for non-redundant with RIO racks.
4. Instruments are typically hardwired to in-rack I/O modules.
5. Distributed I/O (DIO) devices such as MCCs and VFDs are connected in a DIO sub-ring (preferred) or as a DIO cloud. DIO devices connected as a DIO cloud may connect to a dual ring switch (DRS), to the service port of the processor, or to an Ethernet module.

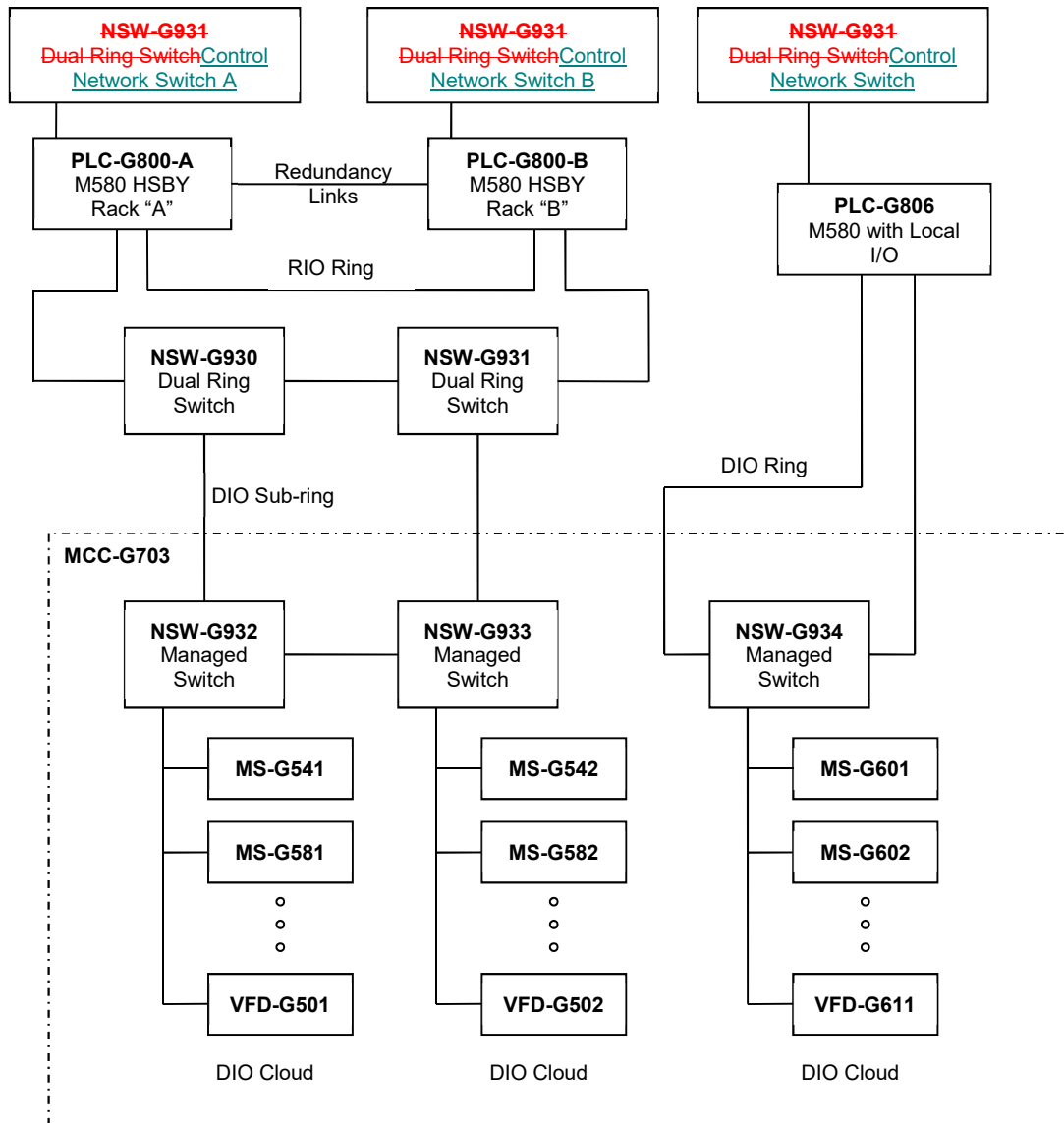

Figure 3-5: Multiple PLCs controlling a single MCC

Notes:

1. Multiple PLCs cannot connect to the same RIO ring. As such, if an MCC must be controlled by separate PLCs, separate networks must be provided to the MCC.
2. An X80 remote I/O rack could be connected in the RIO ring associated with the M580 HSBY pair, but this is not shown.
3. PLC-G806 is connected to network switch NSW-G934 in the MCC using a ring topology. This requires the use of an in-rack Ethernet module such as the BMXNOC0401. Alternatively, a single (non-ring) connection to NSW-G934 can be implemented, but it will not have the same fault-tolerance as a ring topology.

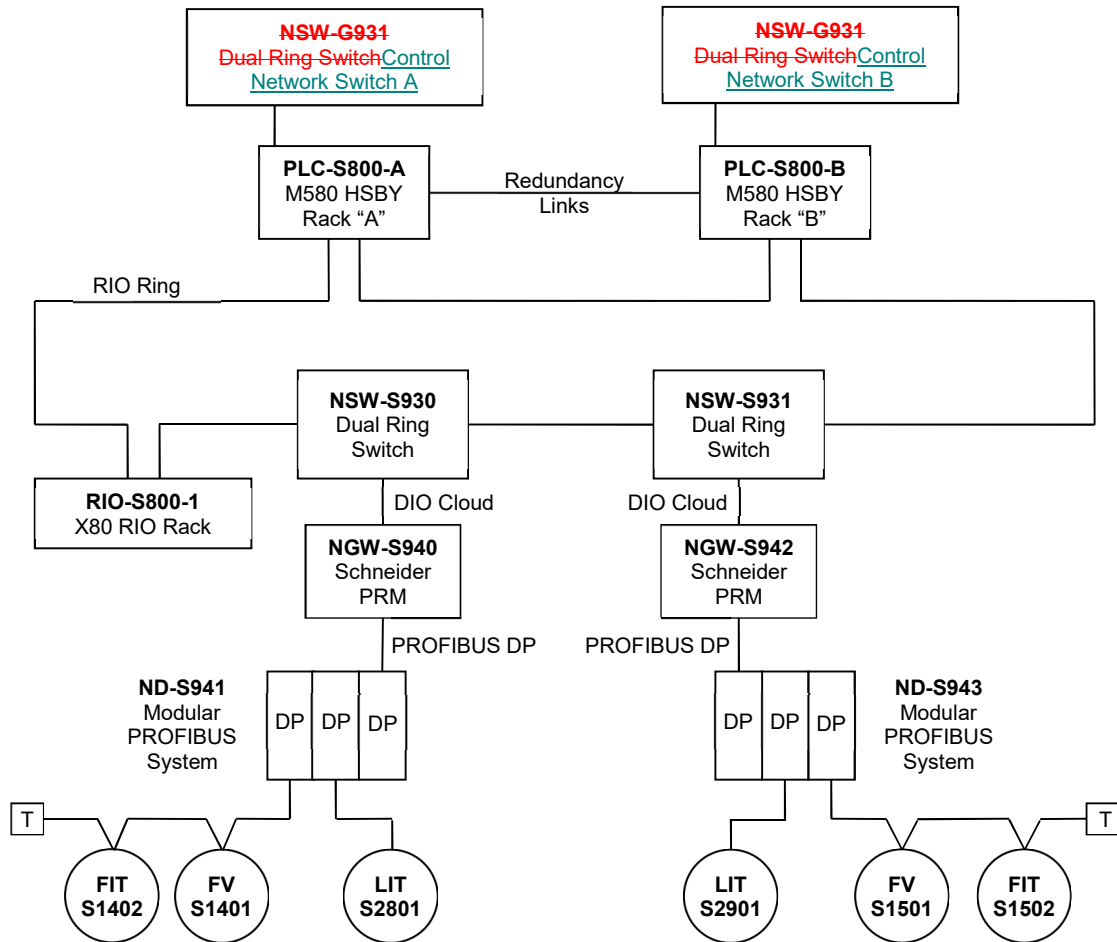

Figure 3-6: Connection of PROFIBUS DP Devices

Notes:

1. The Schneider PRM (Profibus Remote Master) module provides conversion between Modbus/TCP and PROFIBUS DP, and is connected as a DIO cloud to the PLC system.
2. The Schneider PRM may connect directly to the PLC, or to a dual ring switch. In the case of redundant M580 PLCs, the PRM would be connected to a dual ring switch.
3. A modular PROFIBUS system is shown for connection of PROFIBUS devices. This facilitates replacement of PROFIBUS DP devices without affecting the entire PROFIBUS DP network.
4. External terminations are shown at the ends of the PROFIBUS DP segments with more than one instrument, to facilitate replacement of the last device without affecting the segment. Note that if all the instruments on one segment are in the same loop then external terminations may not be required.
5. Group together devices of one process loop on a common PROFIBUS DP segment. FV-S1401 and FIT-S1402 are in the same process loop and therefore share the same PROFIBUS DP segment.
6. Where process equipment and/or instrumentation redundancy is provided, it is encouraged to connect the redundant devices to separate PRM modules, as shown.

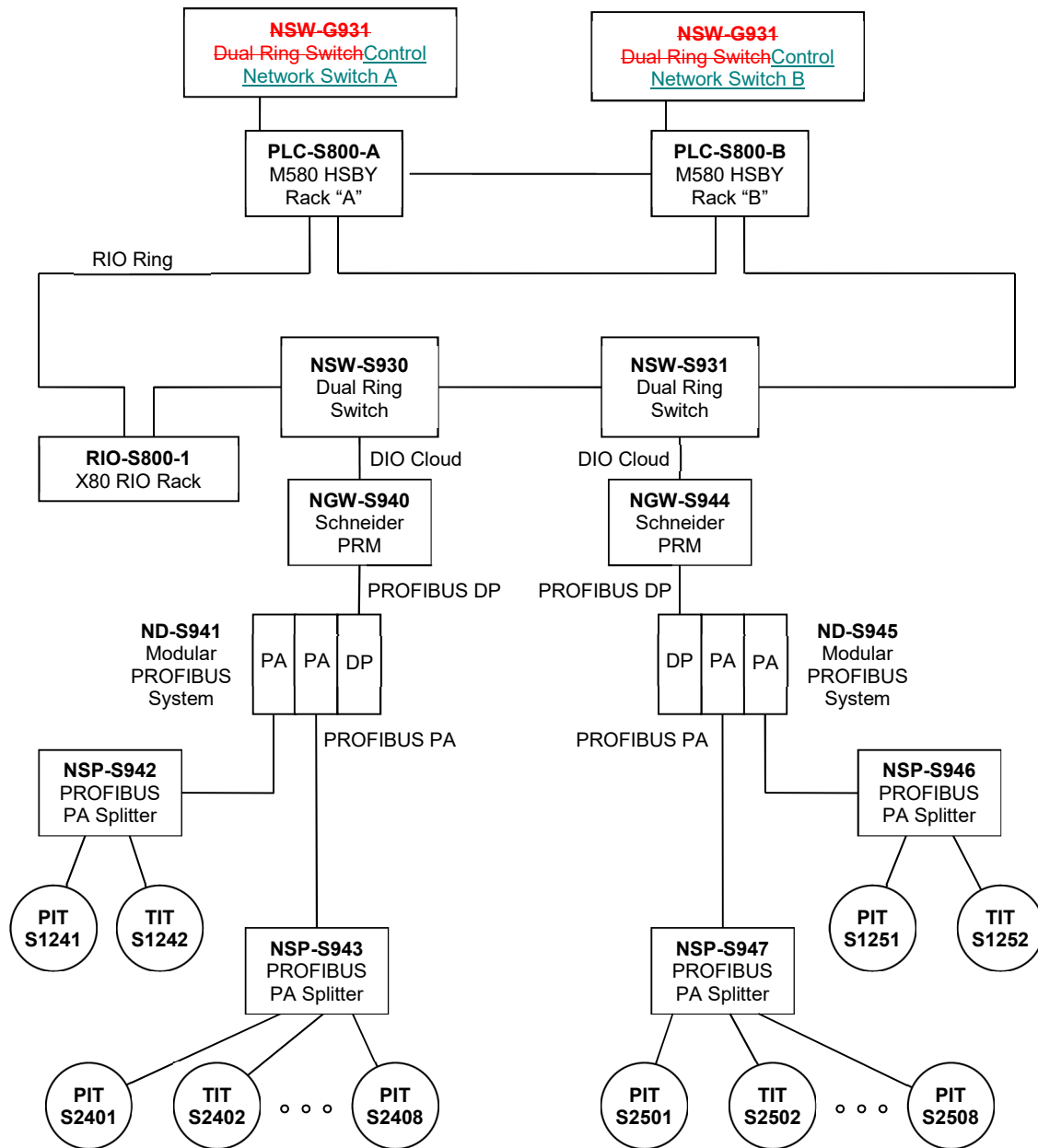

Figure 3-7: Connection of PROFIBUS PA Devices

Notes:

1. PROFIBUS PA splitters (or “segment protectors”) are used in the field to provide spur connections for PROFIBUS PA devices, rather than connecting the devices in a daisy-chain fashion. This allows for easy replacement of individual devices, and prevents an electrical short on one spur from affecting other spurs.
2. Provide multiple splitters (or “segment protectors”) in the field as required to minimize spur lengths.

3.13 PLC Programs

3.13.1 Program Language

The Schneider Electric Modicon PLCs support all five languages defined by IEC 61131-3. However, the specific language used for an application must be selected as per Table 3-. Note that more than one programming language may be used within a single PLC program.

Table 3-6-7: Permitted PLC Programming Languages

Language	Permitted	Notes
Function Block Diagram	Yes	Preferred for most general applications.
Ladder Diagram (Ladder Logic)	Yes	Permitted for specific logic applications with minimal analog control.
Instruction List	Generally Not	May be considered for a very specific subroutine requiring high performance.
Structured Text	Yes	Appropriate for certain math and logic applications.
Sequential Function Chart	Generally Not	May be considered for complex sequencing applications when difficult to implement in a different language.

3.13.2 PLC Configurations and Program Logic

- All PLC configurations and program logic shall be fully accessible and editable by the City of Winnipeg. PLC systems that are password protected, and as a result made inaccessible for modification by the City for any reason, will not be accepted under any circumstance... This applies to PLC systems used in any application, including process and HVAC applications.
- Programs are to be implemented using an object-oriented approach, utilizing user-defined data types and encapsulation where possible.
- Programs are to be implemented using positive logic, meaning that discrete variables are to be named based on the function they perform in the 1 State (True State).
- Use state machine logic for state-based and sequencing applications.
- PLC configuration should support full functionality of Hot/Standby PLC systems when HSBY PLCs are utilized.
- Refer to the City of Winnipeg Tag-name Identification Standard, document code 612620-0014-40ER-0001, for standards regarding naming of tags and function block classes.

3.13.3 Program Structure

- Segregate programs into multiple tasks and routines to improve readability and maintenance of the program.
- The name (identifier) of all tasks and routines shall contain the identifiers of the equipment they are associated with. Exceptions to this rule include system tasks that cannot be renamed, and routines that are not directly associated with equipment such as input/output mapping routines. When using periodic tasks, the priority number and scan rate of the task shall be included in the name of the task.

	Automation Design Guide	Revision: 03	Page 43 of 132
		Document Code: 612620-0013-40ER-0001	

3. The name for each X80 RIO adapter in the configuration shall include the physical rack identifier and the assigned drop number per the rotary switches on the front of the module.
4. The name for each X80 I/O module in the configuration shall include the rack identifier and slot number in which the module is installed.

3.13.4 Program Documentation

1. Provide complete documentation within PLC programs to aid in full understanding of the logic. Note that the level of documentation expected is greater than what an experienced programmer would need, since the programs may be viewed and maintained by personnel who may not have substantial programming experience, or by standby personnel who are not intimately familiar with the facility's operation, or may not be fully familiar with "class based" function block programming.
2. Where documentation is provided for specific logic, avoid creating documentation that simply repeats the logic. Documentation should describe the functionality of the logic. For example, avoid saying "the A bit turns off the B bit after 10 seconds". Instead, say "the discharge pressure sensor turns off the motor after it indicates low pressure for 10 seconds".
3. All routines shall contain a documentation header containing the authoring company name, the date the routine was created, the current revision number of the routine, date of the latest revision, and the document number of the associated Functional Requirements Specification if applicable.

3.13.5 Variable Data Types

1. For each variable tag, use a data type that results in the least amount of memory usage while still providing the required number of significant figures.
2. For all digital (On/Off or True/False) variables, use the BOOL or EBOOL data types.
3. For analog integer variables in the range of -32768 to +32767, use the INT data type (16 bits).
4. For analog integer variables in the range of -2147483648 to +2147483647 and that exceed the range of the INT data type, use the DINT data type (32 bits).
5. Use of UINT or UDINT is to be avoided to ensure that the data is not misconstrued as being signed data by an ancillary system (e.g. Microsoft Excel).
6. For non-integer analog data, use the REAL data type. Do not use the INT or DINT data types with an implied decimal for storing non-integer data.

3.14 Control Modes

Process equipment may be controlled from a number of sources including the PLC system, panel instruments, and manual pilot devices. Operator controls shall be provided on the HMI system and/or in the field for selection of the active control source.

The following equipment operating modes have been defined and are derived from the WWD Electrical Design Guide:

1. Remote Auto/Remote Manual – The equipment is always controlled by the PLC, although may be switched between *Manual* and *Auto* modes via the HMI. Manual controls are provided on the HMI.

	Automation Design Guide	Revision: 03	Page 44 of 132
		Document Code: 612620-0013-40ER-0001	

2. Local/Off/Remote – A Local/Off/Remote switch is provided at the equipment or at the motor controller (e.g. MCC, or VFD). When in *Local* mode, the equipment is controlled via the local pilot devices. When in *Remote* mode, the equipment is controlled from the PLC system.
3. Hand/Off/Remote – A Hand/Off/Remote switch is provided at the equipment or at the motor controller. When in *Hand* mode, the equipment runs continuously. When in *Remote* mode, the equipment is controlled from the PLC system.
4. Hand/Off/Auto – A Hand/Off/Auto switch is provided, with the *Auto* mode providing automatic equipment control via a controller other than the PLC system.

Using the “Auto” designation for PLC system control is not recommended as this designation can conflict with the HMI Auto/Manual modes that may be provided on the HMI/PLC system. The term “REMOTE” should be used.

Where Local/Off/Remote or Hand/Off/Remote switches are provided, connect one of the “Remote” position contacts to a PLC input and program the PLC such that its outputs associated with the equipment are only enabled when in *Remote* mode.

Refer to Section 11 for further details on local controls.

3.15 Cyber Security

Security controls and safeguards shall be provided with all new PCS systems and network installations to prevent internal and external threats from affecting plant assets through system vulnerabilities.

Security controls and safeguards are divided into the several categories including:

1. Corrective – Controls that minimize the effect of an attack and the degree of resulting damage.
2. Detective – Controls that determine if an attack has occurred, or is in the process of occurring, and initiate corrective controls.
3. Deterrent – Controls that reduce the ease in which an external threat can affect assets.
4. Preventative – Controls that prevent external threats from affecting assets.

Controls and safeguards shall be provided to protect against the various types of attacks which include:

1. Passive – Monitoring, capture, and analysis of communication, and decrypting weakly encrypted data.
2. Active – Attempts to circumvent or break encryption, modify information, and introduce malicious code.
3. Close-In – Attaining close proximity to system components to learn about the implementation and modify, gather, or deny access to information.
4. Spoof – Modification of the source address of packets the attacker is sending so that they appear to be originating from someone or something else.
5. Buffer Overflow – Sending more data to a system than is expected, causing complete failure or unexpected operation of the system.
6. Hijack – Taking over a session between two systems and disconnecting one of the systems from communication.

Network firewalls, gateways, and encryption shall be used at appropriate points within the networks to inspect and control network traffic as a means to mitigate attacks. Firewalls shall use techniques such as packet filtering, stateful inspection, deep-packet inspection, and rate limiting.

Firewalls used in the process control system network shall be purpose-built for process control systems, and shall be able to perform packet inspection on common industrial Ethernet protocols such as

	Automation Design Guide	Revision: 03	Page 45 of 132
		Document Code: 612620-0013-40ER-0001	

Ethernet/IP and Modbus/TCP. For example, the following mechanisms shall be provided for Modbus/TCP enforcement:

1. User-definable lists of allowed Modbus unit IDs, commands, registers, and coils.
2. Protocol “sanity check” blocks any traffic not conforming to the Modbus standard.
3. Automatic blocking and reporting of traffic that does not match the rules.

Firewalls shall also incorporate a logging mechanism to allow for routine inspection of event messages to determine if attacks have been attempted, have occurred, or are in progress. In addition to internal logging, the device shall be capable of logging to an external (syslog) monitoring system.

Encryption shall be used for all wireless communication and any inter-plant communication that uses the Internet. Wireless (Wi-Fi) networks shall not use Wired Equivalent Privacy (WEP) as it is easily breakable even when configured correctly. Wi-Fi networks shall use WPA or WPA2 encryption. At minimum, Virtual Private Networking (VPN) shall be used for inter-plant communication or anywhere the Internet is required for transmission of data associated with the process control system. Any addition of wireless systems must be discussed with the City during design.

VPN access must be requested and granted for System Integrator remote access to PCS network.

All Ethernet network switches shall be managed switches and have all unused ports disabled. Network switches shall be password protected with the CoW or ISA standard to the most stringent requirements.

All process control system devices that incorporate password protection shall be configured with a password other than the default password with the CoW or ISA standard to the most stringent requirements. The same password should not be used on multiple devices. External authentication could be explored as an option as regular and standby O&M staff will need access.

Field devices that incorporate physical DIP switches or jumpers to prevent write access to the device and do not require frequent configuration changes should be set read-only to prevent unauthorized or accidental change.

Demilitarized zones with upstream and downstream firewalls should be used for access to such systems as an Information Server and a read-only HMI terminal server. These systems shall still incorporate authentication mechanisms and credentials to prevent access by unauthorized users. Systems in demilitarized zones shall be configured read-only.

Restrict physical access to process control system equipment, including programmable controllers, network switches, and field devices. This may be achieved via a lock on the enclosure containing the devices, or placing the devices in a locked room.

Disable unused services on computer servers to improve security and performance.

Configure user and group security appropriately; do not grant unnecessary privileges.

Avoid use of personal or commercial grade hardware and software components (e.g. virus scanning and firewall software) that may be incompatible with process control system components. For example, some firewall software may block network packets that are required for redundant HMI server synchronization and may prevent failover of the HMI server. Be aware of such issues, and properly configure and test all components.

Computers associated with the process control system shall not be directly connected to the Administration or Security networks. Similarly, computers on the Administration or Security networks shall not be directly connected to the Process Control System Network. Where connections between networks are required, they shall occur through firewalls and must be coordinated with the City's IST group. Any requests for remote access should be made a minimum of 3 weeks in advance.

Components providing system security shall be implemented in a manner that failure of the component acts to disable system functionality rather than disable system security.

Use the following, or most recent, standards and guidelines when implementing system security:

 Winnipeg	Automation Design Guide	Revision: 03	Page 46 of 132
		Document Code: 612620-0013-40ER-0001	

1. NIST Special Publication 800-82, Guide to Industrial Control Systems (ICS) Security,
2. ISA-62443 (formerly ANSI/ISA-99.00.01): Security for Industrial Automation and Control Systems,
3. North American Electric Reliability Corporation (NERC), Critical Infrastructure Protection (CIP) Cybersecurity Standards,
4. NIST Special Publication 800-53, Recommended Security Controls for Federal Information Systems,
5. Department of Homeland Security, Catalog of Control Systems Security: Recommendations for Standards Developers,
6. AMI-SEC Task Force, AMI System Security Requirements,
7. DOD Instruction 8500.2, Information Assurance (IA) Implementation.

 Winnipeg	Automation Design Guide	Revision: 03	Page 47 of 132
		Document Code: 612620-0013-40ER-0001	

4 I/O REQUIREMENTS

Discrete inputs shall be fused as follows:

- At minimum one fuse shall be provided per I/O module. In no event shall a fuse power I/O across more than one module; and
- As minimum one fuse shall be provided per instrument / device / equipment. In no event shall a single I/O fuse be permitted to service multiple instruments / devices / equipment.

Individual fusing of each I/O point is an acceptable means to achieve the above, but is not mandatory.

Discrete input indicating fault/alarm conditions shall be wired to provide high (1) signal for normal state and low (0) signal for fault/alarm state, so that when loop wiring is broken, an alarm will be received by the control system.

 Winnipeg	Automation Design Guide	Revision: 03	Page 48 of 132
		Document Code: 612620-0013-40ER-0001	

5 IDENTIFICATION

All equipment, including but not limited to automation panels, networking panels, junction boxes, instruments, and cables, shall be given an identifier that conforms to the City of Winnipeg Water and Waste Identification Standard. All equipment shall be identified on the drawings and in the field with the same identifier.

	Automation Design Guide	Revision: 03	Page 49 of 132
		Document Code: 612620-0013-40ER-0001	

6 PACKAGED EQUIPMENT SYSTEMS

6.1 Introduction

It is common for some complex systems to be packaged, such that the equipment vendor integrates the automation system tightly together with the equipment, to provide a comprehensive equipment package.

Packaged systems are sometimes supplied with electrical and automation control panels, such that the delivered system only requires service connections to operate. However, in other scenarios the electrical and automation components are specified and supplied independently from the package supplier so that the owner has more control over the configuration and type of electrical and automation components supplied. The City had completed an initiative to standardize on numerous electrical and automation components, and the package vendors may potentially have issues with compliance to these standards. In the event that vendors cannot comply with standardized components the contractor must provide details and reasoning to the City.

Specific wastewater treatment equipment will include packaged solutions from vendors that will include a pre-designed equipment arrangement that may be based on a proprietary design. An example of this is the potential use of high-speed turbo blowers for a BNR system, where the vendor would supply the blower complete with the VFD and integrated controls as part of a packaged unit for each blower. These packaged solutions will include equipment that has been preconfigured to achieve the performance metrics that would be established as part of the vendor's contract obligations. Alteration of these proprietary systems could therefore impact system performance and it is likely that vendors would refuse to provide the requested performance guarantees under these circumstances. It is recognized that equipment components that form part of an overall complex system incorporating significant vendor proprietary knowledge and specialized equipment integration would be difficult to modify without impacting the vendor's ability to meet its stated performance guarantees.

On the other hand, there are instances where part or all of a pre-packaged system includes non-complex and non-proprietary equipment configurations; where the electrical and automation controls can easily be delivered via alternate delivery approaches without significant impact upon vendor performance guarantees. These types of instances would require the vendor to include the City's standardized equipment as part of their system.

6.1.1 Scenario 1 - Comprehensive Vendor Supply

Under this scenario, all package systems, including non-complex systems, are supplied with the manufacturer's standard electrical and automation components and typically integrated into a vendor control panel. The specification would still require compliance with some of the City standards, including identification, voltage levels, etc.

Advantages:

The control system components would be tested and proven by the equipment supplier to properly operate the equipment.

- Single point of responsibility.
- May provide the lowest capital cost, provided the level of PCS integration is minimal.

Disadvantages:

- Additional spare parts must be maintained in the spare parts inventory if the manufacturer and model of supplied components are not the same as the City's standard components.

	Automation Design Guide	Revision: 03	Page 50 of 132
		Document Code: 612620-0013-40ER-0001	

- Additional training may be required for the City to support the electrical and automation components supplied by the package vendor.
- Service will likely require bringing in the vendor's service personnel, who may not be local and thus potentially at significant expense and operational risk.
- The manufacturer and models of the electrical and automation components may not be natively compatible with the City's future control system products. As a result, integration of the two systems may require additional components, such as protocol converters, which require configuration and are additional points of failure.
- The user interface to City personnel would likely not be consistent with the City's standards.
- As the components utilized may be proprietary, the longevity of service and support cannot be guaranteed.
- Some package vendors may desire or even insist on the ability to remote access the system for support or warranties. While this is not necessarily impossible, this would require significant coordination and City IS&T approval as well as segregation of the automation network domain to provide the appropriate security protection.

6.1.2 Scenario 2 – Comprehensive Vendor Supply - City Hardware and Software Standards

Under this scenario, the package vendor for non-complex systems supplies an integrated system with applicable electrical and control components, integrated into a vendor control panel. However, the hardware component manufacturer (and potentially models) would be specified in detail in the tender documents and the City standards given to the vendor to ensure that the package system supplied complies with the City's standards. In addition, City software standards would be provided to the vendor to ensure that the software produced is compliant with the City's requirements. It is assumed that the specification would require City ownership of the final software delivery.

Advantages:

- The control system hardware components would match the City's standard components; therefore, no compatibility issues would arise.
- Single point of responsibility.
- Less training, as the City would be familiar with the components.

Disadvantages:

- The manufacturer of the packaged system may be unfamiliar with the specified control components and may make errors or omissions during the implementation.
- The cost of the packaged system would increase due to potential unfamiliarity with the specified products and requirement arising from additional design efforts to implement the specified solution. In some cases, the vendor may not be able to meet the requirements.
- The level of electrical and automation shop drawing reviews required would be significantly higher due to the fact that the design may be new for the manufacturer and they are likely unfamiliar with the specified products.
- As a library of the City software standards does not currently exist, it would be difficult to provide consistency in programming between the package suppliers and the Systems Integrator.

	Automation Design Guide	Revision: 03	Page 51 of 132
		Document Code: 612620-0013-40ER-0001	

- Where a PLC is supplied by the package vendor, the programming style would likely differ significantly from the rest of the plant, which would be programmed by the Systems Integrator.
- The manufacturer's software programmer may need to spend a significant amount of time on site debugging software, which could increase the commissioning duration.
- The user interface to City personnel would still likely have a different "look and feel" compared to the user interface provided by the Systems Integrator.
- Some package vendors may desire or even insist on the ability to remote access the system for support or warranties. While this is not necessarily impossible, this would require significant coordination and IS&T approval as well as segregation of the automation network domain to provide the appropriate security protection.

6.1.3 Scenario 3 –Vendor Hardware Supply - City Hardware Standards

Under this scenario, the package vendor for non-complex systems supplies an integrated system with applicable electrical and control components, integrated into a vendor control panel. Once again, the hardware component manufacturer (and potentially models) would be specified in detail in the tender documents and the City standards given to the vendor to ensure that the package system supplied complies with the City's standards. However, the programming of the controls would be omitted from the vendor's scope of work. The vendor would be responsible for providing a control narrative for the operation of the package system, which would be utilized by the main Systems Integrator for the overall project to do the programming.

Advantages:

- The control system components would match the City's standard components; therefore, no compatibility issues would arise.
- Less training, as the City would be familiar with the components.
- Single point of responsibility.
- Would provide a high level of consistency from a user interface "look and feel" perspective.
- The implementation details, including program methodology and the HMI animation standards, would closely match the City's standards, thereby reducing confusion for operations and maintenance personnel.

Disadvantages:

- The manufacturer of the packaged system may be unfamiliar with the specified control components and may make errors or omissions during the implementation.
- The cost of the packaged system would increase due to potential unfamiliarity with the specified products and requirement arising from additional design efforts to implement the specified solution.
- The level of electrical and automation shop drawing reviews required would be significantly higher due to the fact that the design is likely new for the manufacturer and they are likely unfamiliar with the specified products.

	Automation Design Guide	Revision: 03	Page 52 of 132
		Document Code: 612620-0013-40ER-0001	

6.1.4 Scenario 4 – Custom Designed Approach

Under this scenario, non-complex packaged systems are supplied without the associated electrical and automation components. These would be designed in advance based upon the expected equipment supply package. The package vendor would be asked to review the electrical and control design, to ensure that it is compatible with their equipment. Note that under this scenario, standardized instruments would be supplied by the package vendor if they are installed by the package vendor on a tightly integrated skid, but would be supplied by the installation contractor if they are installed in the field. Various checks and balances would need to be set in place to ensure that the overall system operates appropriately.

Advantages:

- The control system components would match the City's standard components; therefore, no compatibility issues would arise.
- Fewer spare parts.
- Less training, as the City would be familiar with the components.
- Would provide a high level of consistency from a user interface "look and feel" perspective.
- The implementation details, including program methodology and the HMI animation standards, would closely match the City's standards, thereby reducing confusion for operations and maintenance personnel.
- All electrical and automation drawings would be standard City drawings, under the City's full ownership.

Disadvantages:

- More design drawings would be required to detail the installation of the electrical and automation components. Additional coordination work to ensure that the electrical and control system meets the requirements of the package system.
- In some cases, the manufacturer of the packaged system may try to absolve themselves of any responsibility for warranty-related issues, since they did not supply or configure the control system. This is only expected to be likely for systems with a higher level of complexity or proprietary knowledge. (This can possibly be addressed via appropriate warranty specifications)
- Some scope changes may be required for the systems integrator, based upon changes in the vendor's supply compared to that expected. However, this is dependent upon the contracting strategy.

6.2 Understanding of the City's Priorities

It is understood that the City places a very high value on the long-term operation and maintenance implications of equipment that is incorporated into the Three wastewater facilities. It is also understood that the City has had some previous experience with package control systems, where the maintenance has been more difficult than with custom designed solutions.

In addition, the City underwent a formal E&IC Standardisation process, which included approvals by various City departments, including IST and Corporate Support Services. The use of components different than that standardized could potentially cause issues.

6.3 Package System Requirements

As a general rule, it is required that all electrical and control systems shall be implemented as per Scenario 4, except where the system is complex or proprietary. The decision as to whether a package system is complex or proprietary must be made on a case-by-case basis. Refer to the table below for the packaging strategy for various systems in the Three wastewater facilities scope of supply.

Table 6-1 : Acceptable Package Automation Systems

Description	Catalog Number	Notes
Chassis	BMX XBP ●●00	X-Bus Backplane
	BME XBP ●●00	X-Bus + Ethernet Backplane

Package System	Package Format	Notes
High-Speed Turbo-blowers	Scenario 1	The complexities of the package system require complete vendor control of the deliverable.
Conventional Blowers (>200 hp)	Scenario 1 / 2	It is desired that the electrical starter is fully compliant with the E&IC standardization. The automation is expected to be by the vendor. Scenario 2 is preferred, but Scenario 1 may be accepted upon discussion with and approval of the City.
UV System	Scenario 1	The complexities of the package system require complete vendor control of the deliverable. However, the scope of control shall be limited to the vendor supply.
Centrifuge (rotating above 100 RPM)	Scenario 1	The complexities of the package system require complete vendor control of the deliverable. However, the scope of control shall be limited to the vendor supply.

Package System	Package Format	Notes
Polymer Mixing System	Scenario 2/4	Electrical: The 120VAC motor controls may be proprietary; however, the 600V motor controls should meet the City standards via Alternative 2 or 4. Automation: Either Scenario 2 or 4 is acceptable.
High-Rate Clarifier	Scenario 4	This was previously decided to be custom
Biofilter / Odour Control Systems	Scenario 4	The system is not deemed to be complex or have proprietary controls. The burner controls (if any) would be proprietary and implemented under Scenario 1. The space is not expected to be conducive for significant electrical / controls installations. By selecting Scenario 4 for the electrical, it will allow the starters to be contained in an intelligent MCC.
Perforated Plate Screens	Scenario 4	May have vendor provide a marshalling panel.
Secondary Clarifier Mechanisms	Scenario 4	The vendor may provide instrumentation such as torque switches.
Chemical Feed Pump Skids	Scenario 4	The control of the pump is simple, and does not require significant vendor involvement. It also allows the electrical to be integrated into an MCC. Instrumentation may be supplied by vendor, provided it meets City standards (i.e. flowmeter).
Boilers	Scenario 1	
HVAC Air Handler – Natural Gas fired	Scenario 1/4	The NG Burner management system and directly associated systems will be proprietary (Scenario 1), however all systems not part of the burner management control shall be by PLC. For example, a pre-heat coil control valve shall be controlled by the PLC.

 Winnipeg	Automation Design Guide	Revision: 03	Page 55 of 132
		Document Code: 612620-0013-40ER-0001	

7 LAYOUT / LOCATION REQUIREMENTS

7.1 Control Panels

7.1.1 PLC Panels

PLC control panels associated with wastewater treatment process equipment should be located in dedicated automation or electrical rooms. PLC panels (containing PLC processors) are never acceptable within hazardous locations or dirty / corrosive or wet locations.

Network switches and gateways should be located in dedicated “Networking Panels” rather than inside the control panel, but there are exceptions and in some cases installation of a network switch (e.g. Connexion switch) in a control panel may be appropriate subject to the City’s approval. Networking panels should be provided in each major process area for housing the fibre switches.

7.1.2 Remote I/O Panels

Remote I/O panels should generally be located close to the devices that the I/O wiring connects to, which may be in the field. However, remote I/O panels shall be avoided in Class I, Zone 1 hazardous locations.

7.1.3 Power

The 24 Vdc power supplies associated with each control panel should be located in a separate “Power Supply Panel”.

8 ENVIRONMENTAL REQUIREMENTS

8.1 Ingress Protection

All instruments and panels/enclosures shall have ingress protection against liquids, gasses, and dust for the environmental conditions in which they are used. So far as feasible, control panels should not be located outdoors.

Table 8-1-2 lists the minimum ingress protection for various environmental conditions.

Table 8-1-2: Minimum Ingress Protection for Instruments and Enclosures

Environment	NEMA
Clean indoor air-conditioned area (control, electrical room)	1
Indoor non-corrosive area subjected to dripping	12
Indoor non-corrosive area subjected to wash-down	4
Outdoor non-corrosive area	4
Indoor corrosive area	4X
Outdoor corrosive area	4X

Control panels shall be located at an elevation such that they are not subject to flooding. Additionally, the control panels shall not be located below any piping that may be subject to leaks of any kind.

8.2 Temperature and Humidity Ratings

All automation equipment and instruments located outdoors shall have a minimum operating temperature range of -40°C to 40°C. Equipment exposed to direct sunlight shall be suitable for operation at up to 60 °C.

Where instrumentation and panels are exposed to direct sunlight, a suitable stainless-steel sunshade or cooler shall be provided. Pneumatic instruments (actuators), gauges, switches, etc., generally do not require a sunshade.

All equipment and instruments shall be suitable for high humidity (95% non-condensing) conditions unless installed in a climate-controlled room.

8.3 Cold Environment Requirements

Instrumentation subjected to freezing conditions colder than their minimum operating temperature shall be enclosed within an insulated and heated enclosure to maintain the temperature and humidity requirements of all equipment installed within. Soft covers are not acceptable.

Impulse lines subject to process liquid freezing shall be heat traced and covered.

9 WIRING, CABLING, AND CONDUIT

9.1 Standard Colours

9.1.1 Control Wiring – Wire Colour

Wires shall be colour coded as per Table 9-1-2.

Table 9-1-2: Wire Colour Codes

Conductor Purpose	Colour
Power – 120/240 Vac Supply	Black
Power – 120/240 Vac Neutral	White
Power – 24 Vdc Supply (+)	Blue
Power – 24 Vdc Common (–, or 0 Vdc)	Brown
Discrete Control – ac	Red
Discrete Control – dc	Blue
Intrinsically Safe (IS)	IS (light) Blue
Protective Earth (PE)	Green
Signal Ground / Instrumentation Earth (IE)	Green/Yellow

9.1.2 Network Cable – Jacket Colour

Network cables shall be colour coded as per Table 9-3-4.

Table 9-3-4: Network Cable Jacket Colour Codes

Cable Purpose	Colour
Ethernet, CAT6	Blue
PROFIBUS DP	Purple
PROFIBUS PA, Non-Intrinsically Safe	Black
PROFIBUS PA, Intrinsically Safe	Light Blue
Modbus/RTU (serial)	Grey

9.1.3 Profibus Cable – Conductor Colour

Use the colour scheme indicated in Table 9-5-6 for all Profibus cable connections.

Table 9-5-6: Profibus Cable Conductor Colours

Profibus DP	Profibus PA	Colour
Line A (Rx/D/TxD-N)	PA-	Green
Line B (Rx/D/TxD-P)	PA+	Red

9.1.4 Conduit Colour Coding

Apply colour coded bands to all conduits at points where they enter walls, ceilings, or floors, and at 5-meter intervals. Colour coding shall be as per Table 9-7-8.

Table 9-7-8: Conduit Colour Codes

System	Prime Band	Aux. Band
Power, 120/208/240 Vac	Black	
UPS Power, 120/208/240 Vac	Black	Green
Control Wiring, 120 Vac	Black	Orange
Fire Alarm	Red	
Low Voltage Communication/General	Blue	
Low Voltage Control Wiring, < 50 V	Blue	Orange
Intrinsically Safe	Blue	White

Use a 38 mm wide prime band and a 19 mm wide auxiliary band.

9.2 Cable Types and Ratings

Multi-conductor automation cables are to be of the CIC (Control and Instrumentation Cable) or ACIC (Armoured Control and Instrumentation Cable) type, meeting CSA C22.2 No. 239-09.

Where single-conductor wiring is used, use of RW90 in conduit is acceptable.

Use of appropriate lugs on terminal blocks and ferrules, fork lugs or ring lugs on devices

The voltage rating of automation cables shall meet or exceed the highest voltage present in the control panel or equipment in which the cable is used.

Refer to the City's Sewage Treatment Program standard equipment specifications for further details on cable specifications.

9.2.1 Cable Requirements

Control and Instrumentation cables:

- CIC or ACIC, XLPE RW90, 600/300V, with 100% insulation.
- 600V rated cable is to be utilized for any cable termination in an enclosure containing voltages above 300V.
- Phase/polarity numbering marking/colour codes – Standard numbering and colour coding.
- Jacket – Black PVC jacket rated FT-4 and low acid gas emitting. The jacket will be UV, moisture and oil resistant.

Ethernet Cables

CAT 6 Cable

- FT4
- Cable selection (CMP, CMP, etc.) should be appropriate for the installation.

	Automation Design Guide	Revision: 03	Page 59 of 132
		Document Code: 612620-0013-40ER-0001	

Fibre Optic Cables:

Outdoor Fibre Optic Cable

- Fibre Requirements:
 - Single-mode
 - Fiber Category: OS2
 - Maximum Attenuation: 0.4 / 0.3 dB/km
 - Chemical Resistance: RoHS
 - Approvals: CSA FT-4-ST1
 - Manufacturer and Model:
 - Corning 036EUL-T3601D2M or approved equal
 - Multi-mode
 - Fiber Category: OM3
 - Maximum Attenuation: 0.4 / 0.3 dB/km
 - Chemical Resistance: RoHS
 - Approvals: CSA FT-4-ST1
 - Manufacturer and Model:
 - Corning 036EUL-T3601D2M or approved equal

Indoor Fibre Optic Cable

- In accordance with requirements of EIT/EIA 568, section 12.5
- Manufacturer:
 - Corning 040402R5Z200xxM (where xx is length in metres) or approved equal

9.3 Use of Conduits vs. Cables

In general, the decision to use conduits or cables should be based on the specific details of the application. In general, cables in cable tray is preferred for new installations; however, there are cases where the use of conduits is appropriate. It is acceptable for a facility to have a mixture of conduits and cables.

Conduits shall be used in the following applications:

1. Where the existing installation is conduit based.
2. Fire alarm systems.
3. Where aesthetics are a concern.
4. Where there is potential for physical abuse or damage.
5. Where the specific cables required do not have an FT4 rating.

9.4 Conduit Materials and Sizes

Use rigid conduit, except where flexible conduits are required for maintenance of equipment or in areas where the equipment is subject to vibrations during operation (compressors, motors, etc.), to reduce the effect on connections. This should not be used >2m. EMT may be used within office areas if there are no environmental issues.

Rigid galvanized steel conduit is not acceptable for use within wastewater facilities. See Table 9-9-10.

Conduit boxes to be aluminum with cast covers. Use spring door covers for areas with circulating dust and contamination.

Conduit installation on unpainted concrete to be mounted with PVC spacers to prevent corrosion.

Table 9-9-10 : Facility Conduit Application

Application	Type
In poured concrete walls and floors	PVC
Underground	PVC
General Use	Rigid Aluminum
Locations with presence of agents that cause corrosion of aluminum	PVC
Exterior	Rigid Aluminum
Hazardous Locations	Rigid Aluminum
Office and similar locations, without environmental contamination.	EMT

9.5 Junction Boxes

Junction boxes with terminals shall be used for automation cable connections. Joints or splices to automation wires within junction boxes without the use of terminals are not acceptable.

Junction boxes shall have an area to one side of the terminal strip reserved for the homerun cable(s). If there are two terminal strips the area between the two strips shall be reserved for the homerun cable(s).

Sufficient space for the homerun cable gland(s) must be allowed for in junction boxes. Holes for the homerun cable glands are to be punched on site unless they are explosion proof boxes.

All cables and conduits should enter the bottom of the junction box. Cables should not enter the top of the enclosure in order to avoid the issue of liquid ingress.

All junction boxes installed outside shall be supplied with an air breather/drain approved for the area classification.

Physical separation of cabling within junction boxes shall be provided for each type or category of signal, as follows:

1. Low level analog millivolt signal cables (TC, strain-gauge),
2. 12 to 24 VDC discrete signals and high-level analog DC signals (4-20 mA, 0-5 V, etc.),
3. 120/240 VAC discrete signals,
4. Intrinsically Safe (IS) signals.

	Automation Design Guide	Revision: 03	Page 61 of 132
		Document Code: 612620-0013-40ER-0001	

9.6 Cable Trays

1. A side rail height of 152 mm (6") is preferred. Use 102 mm (4") side rail height where vertical space is limited.
2. Size cable tray to meet current and future cable requirements. Minimum tray width is 152 mm (6").
3. Tray to be CSA, cUL listed.
4. The rungs of the ladder shall typically be at 229 mm (9") spacing.
5. Cable tray load ratings shall be sufficient for the cables installed and any additional loads such as snow, ice and wind, where applicable.
6. Allow for spare cables in cable tray loading calculations.
 - a. Minimum load rating for indoor tray: CSA Class C1
 - b. Minimum load rating for outdoor tray: CSA Class D
7. Use tray covers for mechanical protection in dusty areas, outdoors, and for trays passing under walkways or where there is a risk of falling debris.
8. Use aluminum cable tray in wastewater treatment facilities.
 - a. Consider the use of fiberglass cable tray in corrosive locations. Fiberglass tray shall not be exposed to sunlight unless confirmed by the manufacturer that it is sunlight/UV resistant.

9.7 Shield Termination and Grounding

1. Instrument cable overall shields and individual shields are to be grounded at one end only to avoid ground loops. The non-grounded end should be sealed with heat shrink tubing or another means so it cannot be grounded intentionally or unintentionally.
 - 1.1 For non-intrinsically safe wiring, where an incoming shielded cable and an outgoing shielded cable connect at a set of terminals and one of the cable shields is grounded elsewhere, use insulated feed-through terminals to connect the shields of the incoming and outgoing cables.
2. Instrument overall and individual cable shields should be grounded at the control panel or I/O marshalling cabinet.
 - 2.1 RTDs embedded in windings of medium and high voltage (> 1 kV) motors shall be bonded to ground in a junction box to avoid fault currents from propagating into control panels or I/O marshalling cabinets.
3. Except for grounded thermocouples, all of the shield drain wires shall be cut and heat shrunk in the field near the instrument.
4. Exposed parts of the drain wires should be inside insertion jackets. Drain wires for different loops should not touch each other within the junction boxes, I/O or marshalling cabinets. All exposed parts of drain wires should be covered with heat shrink to ensure isolation.
5. PROFIBUS cable shields should be grounded at both ends to improve noise rejection, unless ground loop currents prevent proper operation of the communication cables, in which case the cables may be grounded at one end only. Provide an insulated, 12 AWG, equipotential bonding conductor along with all PROFIBUS cabling to minimize currents in the cable shields.

	Automation Design Guide	Revision: 03	Page 62 of 132
		Document Code: 612620-0013-40ER-0001	

6. If intrinsic safety is required, the intrinsic safety ground system shall have a dedicated ground conductor or bus that is isolated from the safety ground, except for a single connection to the building electrode ground, to prevent ground fault currents from entering the intrinsically safe system.

9.8 Signal Noise Prevention

1. Analog signals such as 4-20 mA, RTD, thermocouple, pulses, and milli-Volts shall use individually shielded twisted pairs or triads.
2. Where practicable, 24 Vdc discrete signals such as relay contacts, process switches, solenoids, and limit switches should use twisted pairs or triads with overall shield but individual shielding is not required.
3. Analog and discrete signals shall not share the same multi-pair/triad cable.
4. Each signal shall have its own return wire extending from the source to the destination to protect against common impedance coupling.
5. It may be useful to ground spare wiring in marshalling cabinets and junction boxes to minimize potential noise pickup.
6. Where signal noise is an issue, use of isolated analog PLC I/O modules may be considered.
7. Signal isolators may be installed to prevent ground loops, prevent passage of noise between cables via the common reference, or split a signal for multiple pieces of equipment. Signal isolators shall not to be used on communications cabling.

	Automation Design Guide	Revision: 03	Page 63 of 132
		Document Code: 612620-0013-40ER-0001	

10 HMI SYSTEMS

10.1 Locations

The HMI clients will include desktop clients in the main control rooms and in area control rooms or determined by contract. Where walking distance to a control room is excessive, local ruggedized touchscreen terminals shall be provided near process equipment. The network connections to all fixed field operator workstations shall be hardwired.

10.2 Standards

The following information shall be provided on HMI systems for display of automation equipment status and facilitate control. The following is not comprehensive in nature, but represents the minimum requirements.

1. HMI system equipment:
 - a. Primary and secondary HMI server operational status,
 - b. Indication of which HMI server is acting as primary, secondary,
 - c. Manual controls for switching between primary and secondary HMI servers,
 - d. HMI server resource utilization,
 - e. Historian server status,
 - f. Historian server resource utilization,
 - g. Database status information e.g. Low space,
 - h. HMI client license usage.
2. Programmable Logic Controller (PLC) equipment:
 - a. PLC operating mode (Run / Remote / Program),
 - b. PLC fault status,
 - c. For redundant PLCs:
 - Indication of which controller is primary, secondary,
 - Manual controls shall be provided to facilitate switching between the primary and secondary controllers for users with appropriate privileges,
 - d. Resource utilization,
3. Networking equipment:
 - a. Network switch status,
 - b. Firewall status and alarms,
 - c. Communication gateway (PROFIBUS / Modbus / etc.) status,
 - d. Network Time Protocol server status,
4. Plant process:
 - a. Equipment mode (e.g. Hand, Off, Remote, etc.),
 - b. Equipment operating status (e.g. Not Ready, Running, Faulted, etc.),

	Automation Design Guide	Revision: 03	Page 64 of 132
		Document Code: 612620-0013-40ER-0001	

- c. Equipment manual controls,
 - d. Duty assignments for redundant equipment,
 - e. Instrument readings in engineering units,
 - f. Process control setpoints and modes,
 - g. PID controller PV, SP, CV (read-only on HMI systems),
 - h. Equipment and plant operating limits to allow operators to react before an alarm is generated,
 - i. Adjustable alarm setpoints,
 - j. Plant statistics (daily/monthly flow totals, etc.)
5. General:
- a. Alarm management system,
 - b. Screen navigation buttons,
 - c. Date and time,
 - d. Currently logged-in user,
 - e. Links to help system / plant operating manuals, if available, and
 - f. Mathematical constants page.

10.3 HMI Standards and Reference Material

Use the following City of Winnipeg documents in the development of HMI system applications:

1. Tag name Identification Standard, document code 612620-0014-40ER-0001,
2. HMI Layout and Animation Plan, document code 612620-0015-40ER-0001,
3. Historical Data Retention Standard, document code 612620-0016-40ER-0001.

The following guidelines may be referenced as required:

1. ASM Consortium Guidelines, Effective Operator Display Design,
2. ASM Consortium Guidelines, Effective Alarm Management Principles.

11 LOCAL USER INTERFACE

11.1 General

The local user interface for equipment may be composed of physical pilot devices, a touchscreen HMI terminal, or a combination of the two. Where both pilot devices and a touchscreen HMI are used, the pilot devices shall be associated with essential and/or safety functions only.

Pilot devices, including push buttons, selector switches, and pilot lights are to be of the heavy-duty, dust and oil-tight type, rated for the area in which they are used.

11.2 Pilot Device Colours

Where pilot devices are use, the color convention shall be as follows:

Table 11-1-2: Standard Pilot Device Colours

Purpose	Pilot Device Colour
Running Status Light	Green
Stopped Status Light (not normally provided)	Blue
Position Open Status Light	Green
Position Closed Status Light (except switchgear)	Blue
Alarm Status Light – Major or Safety	Red
Warning or Minor Alarm Status Light	Amber
Ready Status Light	Blue
Operating Mode Light – Normal Mode	Blue
Operating Mode Light – Alternate Mode	Amber
Start Pushbutton	Green
Stop Pushbutton	Red
Test Pushbutton	Black
Reset Pushbutton	Black
E-Stop Pushbutton	Red (Note 3)
Overload Reset Pushbutton	Blue with White “R”
Selector Switch	Black with White Insert

Notes:

- The pilot light colours used are selected from an operations perspective.*
- Use of white or clear lens pilot lights is not permitted as it is difficult to discern whether they are illuminated in brightly lit areas.*
- Emergency stop pushbuttons to be push-pull maintained operators with red mushroom cap.*

	Automation Design Guide	Revision: 03	Page 66 of 132
		Document Code: 612620-0013-40ER-0001	

11.3 Touchscreen HMIs

Touchscreen HMIs can provide more functionality than pilot devices but come at a higher installed cost due to the labour involved with software configuration and testing. Use a touchscreen HMI rather than pilot devices if the equipment requires more than eight pilot devices to facilitate local control, or requires operator input or indication of analog values. Requirements for push buttons related to emergency requirements of equipment must be utilized even if HMI is provided

HMI (software) Auto/Manual modes may be provided on the HMI/PLC system to facilitate manual control of equipment via the PLC. City review is required for these situations.

The hardware and software of touchscreen HMIs should be consistent with the City's standardization agreements.

11.4 Typical Manual Controls

Manual controls in the form of physical pilot devices may be provided for equipment to facilitate maintenance activities or for control of the equipment during PLC system failure. Manual controls should be located adjacent to the equipment but may be located elsewhere on a control panel or on a Motor Control Centre (MCC) if mounting adjacent to the equipment is not practicable.

Refer to the standard control modes defined in Section 3.14. Where manual controls are provided for equipment, selector switches are typically provided in the field for selecting between the available control modes.

The City has standardized on the following control mode switch configurations:

1. Local/Off/Remote (L/O/R) selector switch with local pilot devices for manual control, and local pilot lights to indicate status.
2. Hand/Off/Remote (H/O/R) selector switch with pilot lights to indicate status. No additional manual controls are typically provided.
3. Hand/Off/Auto (H/O/A) selector switch with pilot lights to indicate status. No additional manual controls are typically provided.

Remote mode implies equipment control is from the PCS system, and *Auto* mode implies equipment control is from some automatic controller, other than the PCS system. When equipment is in *Hand* mode, the equipment is run continuously.

The use of Lock-Off-Stop (LOS) pushbuttons are prohibited for City of Winnipeg design as they do not provide the required level of electrical isolation for maintenance activities. Use a local disconnect switch if electrical isolation is required.

Emergency stop pushbuttons (e-stops) shall be provided for equipment that presents a safety hazard to personnel (e.g. unguarded rotating machinery). Design the emergency stop circuit such that the equipment requires a fresh start command to restart upon releasing the e-stop pushbutton. E-STOP buttons shall be included at each location of control for equipment including Control Panels (CP) & Local Control Panels (LCP)

Typical manual control requirements are indicated in Section 7.8 – Motor Local Controls of the Electrical Design Guide, document 510276-0000-47ER-0001, following for single speed and VFD controlled motor driven equipment.

	Automation Design Guide	Revision: 03	Page 67 of 132
		Document Code: 612620-0013-40ER-0001	

12 CONTROL PANELS

12.1 Heating, Ventilation, and Cooling

Control panels shall be provided with heating, ventilation, and/or cooling as required to ensure the internal temperature and humidity are maintained at acceptable levels for the components within.

Perform a heat-load analysis for all control panels containing heat-generating components. Determine if the thermal dissipation via the enclosure walls is sufficient or if additional cooling is required. If additional cooling is required, consider installing filtered louvers at opposite corners of the control panel to provide cooling through natural convection. If natural convection is insufficient, install a filtered fan unit to provide forced air flow through the panel.

Where fans are provided on control panels, ensure that the fans positively pressurize the cabinet to prevent ingress of contaminants through small openings.

Panels installed in cold or outdoor locations may require an internal heater and thermostat to maintain the temperature and humidity above the minimum required for the internal components.

An additional cabinet dryer or heater may be required for control panels installed in humid locations to prevent build-up of moisture within the panel, and to prevent corrosion of internal components.

Provide the mandatory ventilation clearances around heat-generating components as specified by the component manufacturer. Indicate mandatory component clearances on the panel layout drawings.

12.2 Spare Space

Control panels are to be provided with a minimum 20% spare space to facilitate installation of additional terminals, relays, and other components in the future. Spare space shall be logically distributed throughout the panel rather than concentrated to one area, and dimensioned on the control panel layout drawing.

The mandatory ventilation clearances around equipment shall not be considered as spare space.

For chassis-based PLCs, a minimum of 20% spare space shall be provided within the chassis for the future addition of modules. Alternatively, space could be provided within the control panel for the addition of another PLC chassis in the future.

12.3 Wireways

Provide narrow-slot, ventilated wireways complete with snap-on covers within all control panels to contain both the internal panel wiring and incoming/outgoing field cabling/wiring.

Size wireways such that they are not more than 40% full once the wiring is installed. Wireway design should follow the CSA requirements related to wiring categories identified in Table 12-1.2.

Provide a minimum of 50 mm spacing between wireways and adjacent devices such as terminals and relays. This is to facilitate clear viewing of the wire identification marking, and for insertion and removal of the wiring to the device.

Provide a minimum of 19 mm separation between ventilated wireways containing intrinsically safe wiring and ventilated wireways containing non-intrinsically safe wiring.

Use grey wireways for normal (non-intrinsically safe) wiring and light blue wireways for intrinsically safe wiring.

Wiring run to the door of the control panel shall be appropriately grouped, tied together at short intervals with nylon cable ties, and secured to the door using adhesive backed cable tie mounts in a manner that minimizes stress on the wires.

Categorize and group conductors based on their application. Provide separate wireways for conductors of each category in order to minimize electromagnetic interference. Categories 3 and 4 may be combined if space is limited. Wiring categories are provided in Table 12-1-2.

Table 12-1-2: Wiring Categories

Category	Description	Examples
1	AC Power and Control	<ul style="list-style-type: none"> • AC power for power supplies • 120 Vac control wiring • 24 Vac control wiring to HVAC devices
2	DC Power and Control	<ul style="list-style-type: none"> • DC power • DC control wiring
3	Analog Signals	<ul style="list-style-type: none"> • Analog I/O
4	Communications	<ul style="list-style-type: none"> • Communication cables

12.4 Cable Entry

The location of cable entry into the panel should be determined prior to designing the layout of the control panel as component layout can affect the routing of field cabling. The cable entry must be on the same side as the terminations in the panel so cables don't traverse the width or height of the panel.

Recommended point of cable entry for control panels is at the bottom of the enclosure. Top entry of cables is only permitted in dry locations.

12.5 Power Supply Voltage

PLC control panels in control/automation rooms should be powered by 24 Vdc from an external power supply panel adjacent to the control panel. However, when retrofitting for existing DCS replacement, the 24 Vdc power supplies may be located in a DCS cabinet.

Small control panels and remote I/O panels in the field may be powered by 120 Vac on UPS feeds

12.6 Control Voltage

Use 24 Vdc signalling for discrete I/O rather than 120 Vac where possible in order to reduce shock and arc flash hazards.

12.7 Grounding and Bonding

Control panels with I/O, 24 Vdc power supplies, or shielded network cabling shall be provided with both a non-isolated electrical (safety) ground bar and an isolated instrumentation ground bar. The non-isolated electrical (safety) ground bar shall be used for bonding components such as the enclosure wall, enclosure door, back-panel, PLC chassis, and 120 Vac powered equipment to the building electrical (safety) ground. The isolated instrumentation ground bar shall be used for bonding

	Automation Design Guide	Revision: 03	Page 69 of 132
		Document Code: 612620-0013-40ER-0001	

instrumentation cable shields, the DC supply common, shielded network cabling, and other sensitive components to the building instrumentation ground.

Locate the isolated and non-isolated ground bars at logical and convenient locations within the control panel to minimize the length of bonding conductors. Generally, the ground bars are to be located at the point of cable entry into the panel.

Provide a lamacoid or label adjacent to the isolated instrumentation ground bar reading "Isolated Ground".

Ensure that any paint or other such insulating materials are scraped off of components at the point where bonding conductors attach. Use star washers at the mating surface to ensure a proper bonding connection.

Where a control panel is powered from a 120 Vac source, the bonding connection associated with the 120 Vac supply shall be connected to the electrical (safety) ground bar within the control panel (either directly or via a feed-through terminal).

Instrumentation cable overall and individual shield drain wires shall connect to insulated feed-through terminals on the terminal block DIN rail. These feed-through terminals shall then be connected together via insulated jumpers (either on the side or down the centre of the terminals), and the first or last terminal be bonded to the isolated instrumentation ground bar. In this way, the instrumentation cable shields are not connected directly to the electrical (safety) ground. Provide insulation on bare drain wires as required to prevent accidental bonding to electrical (safety) ground. For smaller panels, drain wires may be directly connected to the isolated ground bar rather than through feed through terminals, but the drain wire must be insulated to prevent contact with the electrical (safety) ground.

All bonding conductors shall be connected in a star, and not be daisy chained. Bonding conductors shall be insulated, stranded copper, 14 AWG or larger. Use green insulation on bonding conductors associated with the electrical (safety) ground, and green/yellow insulation on bonding conductors associated with the instrumentation ground.

Existing buildings may not be equipped with both an electrical (safety) ground and instrumentation ground. In this situation, the isolated instrumentation ground bar within the control panel should be connected to the building star ground, or as close to the building electrode ground as possible. If these options are not feasible, a single bonding link would be provided between the non-isolated electrical (safety) ground bar and the isolated instrumentation ground bar within the control panel, in order to bond the isolated instrumentation ground bar to ground. If at a later time the building is provided with an instrumentation ground, remove the bonding link in the panel and bond the panel's isolated instrumentation ground bar to the instrumentation ground.

Refer to Section 20 for further information on grounding.

12.8 Terminals

Terminals are to be provided for termination of field wiring and internal panel wiring. The standardized brand used in the Wastewater Services Division is Phoenix Contact.

All terminals are to be of the screw connection type.

Where possible, use plug-in bridges rather than wire jumpers to connect terminals together within a terminal block.

All field cabling/wiring and internal panel wiring to terminal blocks require lip lugs/ferrules. No bare wires allowed.\

All wiring to devices requires ferrules, fork or ring lugs unless approved by manufacturer. No bare wires allowed

12.9 Terminals for Hardwired I/O Terminations

The terminals listed in Table 12-3-4 are the preferred terminals for termination of hardwired I/O signals and for connection to PLC I/O modules.

Table 12-3-4: Hardwired I/O Terminations

Application	Function	Terminal Type
Analog Input/Output, 2-wire Transmitters	24 Vdc Loop Power	Fused Terminal
	4-20 mA Signal	Disconnect Terminal
	24 Vdc Common	Feed-Through Terminal
	Shield Drain	Feed-Through Terminal (<i>Note 1</i>)
Analog Input/Output, 4-wire Transmitters	4-20 mA Signal	Disconnect Terminal
	4-20 mA Common	Feed-Through Terminal
	Shield Drain	Feed-Through Terminal (<i>Note 1</i>)
Discrete Input	24 Vdc / 120 Vac Supply to Field	Double-Level Fused Terminal
	Discrete Input Signal	
Discrete Output	Discrete Output Signal	Double-Level Fused Terminal
	24 Vdc Common / Neutral	

Notes:

1. *Feed-through terminals are used for terminating analog shields in the case where the associated DIN rail is bonded to the enclosure's electrical (safety) ground. If an isolated DIN rail is provided, which is only connected to the isolated instrumentation ground bus in the enclosure, potential earth terminals may be used instead of feed-through terminals.*

It is recommended to use Schneider Electric cord sets to connect high-density discrete I/O modules to the field terminals. These cord sets are available with flying leads for termination to standard screw-connection terminals.

The use of Schneider Electric TeleFast blocks is not typically recommended and use of them requires special approval from the City.

12.10 Lighting

Interior lighting should be provided for all floor-standing automation control panels, and all wall-mount automation control panels 762mm (30") wide by 914mm (36") tall or larger.

Control panels that contain 120 Vac I/O may contain a 120 Vac powered LED interior light fixture. Use a 24 Vdc LED lighting strip for control panels operating at 24 Vdc.

Provide a door-actuated switch for control of the interior light.

12.11 Shelves

Provide an internally-mounted shelf on automation control panels that contain a programmable logic controller. The shelf is to provide support for a laptop computer used for local PLC programming and maintenance.

 Winnipeg	Automation Design Guide	Revision: 03	Page 71 of 132
		Document Code: 612620-0013-40ER-0001	

12.12 Laptop Receptacle

A GFCI protected 120 Vac receptacle shall be provided with control panels that contain a PLC or any other equipment that is capable of Laptop connection. The receptacle should be located inside the panel and fed from 120 Vac non-essential panel

Control panels that operate at 24 Vdc (with no 120 Vac present in the panel) should not contain a laptop receptacle. Instead, a receptacle should be installed outside of and adjacent to the control panel.

	Automation Design Guide	Revision: 03	Page 72 of 132
		Document Code: 612620-0013-40ER-0001	

13 MOTOR CONTROL

13.1 Standard Equipment

The City of Winnipeg has standardized on the use of Schneider Electric motor control centres (MCCs), variable frequency drives (VFDs), and soft-starters for motor control applications operating at 600V and below. Where such motor control equipment is required, specification of the equipment from the chosen manufacturer is mandatory for all new installations.

13.2 Control and Monitoring

13.2.1 General

Control and monitoring of MCCs, VFDs, and soft starters may be implemented in multiple ways, as follows:

1. **Hardwired control and monitoring** – all control signals are hardwired to the controlling device (e.g. the PLC system or a field instrument) and monitoring signals are hardwired to the PLC system. This method typically has highest reliability but also has highest installation costs due to the requirement for installing and terminating significant amounts of field cabling.
2. **Hardwired control, network monitoring** – all control signals are hardwired to the controlling device and all monitoring signals are obtained through a network connection. This method has acceptable reliability and often lower installed cost than a fully hardwired system, but control may be affected by a network failure. This method has the advantage that significant monitoring information can be obtained from network-connected motor controllers. Note that inclusion of network-based monitoring will increase the cost of the components.
3. **Network control and monitoring** – all control and monitoring signals are conveyed through a network connection. This method has acceptable reliability if the network is properly implemented, and typically has the lowest installed cost due to the elimination of all hardwired automation cabling. The increased component cost is offset by the elimination of the hardwired cabling. Significant monitoring information can be obtained from the motor controller.

The City of Winnipeg has standardized on the use of network control and monitoring for most motor control applications utilizing MCCs, VFDs, and soft starters. The primary reasons are the reduced installed costs due to the lack of hardwired cabling, and the increased diagnostics information available from network-connected motor controllers.

Hardwired control may be used for simple applications where there is little financial or operational benefit from using network control and monitoring, or where equipment configuration or system requirements may govern. Cases where hardwired methods would be used may include VFDs used for an HVAC application, a motor starter that is not controlled by the PLC system, packaged system applications, or other configurations identified by the designer. Devices that include clock/time functionality should synchronize to the PCS clock.

Hardwired control and monitoring would typically be used for very critical applications, but should generally be limited to critical applications having insufficient process equipment redundancy to mitigate against network failures.

13.2.2 Low Voltage Motor Control Centres

The City's standard MCC for use in wastewater treatment facilities is the Schneider Electric Model 6 intelligent MCC with Tess T motor management relays. The TeSys T motor management relays may

be ordered with various communication interfaces, logic input voltage ratings, and with an optional extension module, as discussed in the following.

Use the Ethernet TCP/IP communications interface on all TeSys T motor management relays. The Ethernet TCP/IP interface allows for control and monitoring of the motor controller by the PLC system utilizing the Modbus/TCP protocol. Note that the Ethernet TCP/IP interface also incorporates a device webpage on HTTP port 80.

For the logic inputs on the TeSys T, the City typically uses the 100-240 Vac option, with the power source for the inputs being the control power transformer in the MCC unit compartment. The logic inputs are commonly used for control interlocking with motor disconnect switches and process instruments in the field.

The extension module has a part number beginning with “LTM E” and incorporates 3-phase voltage monitoring. It allows for undervoltage and overvoltage functions to be incorporated into the protection scheme, and allows for computation of power factor, power, and energy usage. Provide the extension module for all motors larger than 74.6 kW (100 HP) since the additional monitoring and diagnostics information may be useful for future maintenance activities. It is not required to provide the extension module for motors less than 74.6 kW (100 HP), but may be provided if desired.

Motor soft starters are typically installed in MCCs, unless the size and/or cooling requirements are prohibitive. Where soft starters are used in an MCC, they are installed in the unit compartment with a TeSys T motor management relay to provide network control and monitoring.

Typical control and monitoring points for intelligent MCCs with the TeSys T motor protection relay are listed in Table 13-1-2.

Table 13-1-2: Low Voltage, Intelligent MCC Starter – Typical Control and Monitoring Points

Motor Size	Typical Control Points	Typical Monitoring Points
All motors	<ul style="list-style-type: none"> • Run command • Reset command 	<ul style="list-style-type: none"> • Local/Remote, Hand/Off/Remote, or Manual/Off/Remote switch • Ready • Running • Fault • Average motor current • Accumulated run time • Out of service (e.g. a communication failure)
≥ 37.3 kW (50 HP)		<ul style="list-style-type: none"> • 3-phase motor currents
≥ 74.6 kW (100 HP)		<ul style="list-style-type: none"> • 3-phase motor voltages • Power factor • Power • Energy

Notes:

1. Refer to the *Electrical Design Guide*, document 510276-0000-47ER-0001, for typical motor protection requirements, which should be monitored by the process control system.

Where hardwired control is used with non-intelligent MCCs, provide the control and monitoring points indicated in Table 13-3-4.

Table 13-3-4: Low Voltage, Hardwired MCC Starter – Typical Control and Monitoring Points

Motor Size	Typical Control Points	Typical Monitoring Points
All motors	<ul style="list-style-type: none"> Run command 	<ul style="list-style-type: none"> Local/Remote, Hand/Off/Remote, or Manual/Off/Remote switch Ready Running Overload tripped
≥ 37.3 kW (50 HP)		<ul style="list-style-type: none"> Motor current (single phase) Accumulated run time Starts per hour
≥ 187 kW (250 hp)		<ul style="list-style-type: none"> 3-phase motor current

Notes:

1. Refer to the *Electrical Design Guide*, document 510276-0000-47ER-0001, for typical motor protection requirements, which should be monitored by the process control system.

13.2.3 Low Voltage Variable Frequency Drives

The City has standardized variable frequency drives for low voltage applications in the sewage treatment program. Refer to the *Electrical Design Guide*, document 510276-0000-47ER-0001 for VFD requirements.

Smaller VFDs should be located within MCCs, however, installation of VFDs within vendor supplied equipment is also permitted provided that the equipment is not on the roof (heating issue) and not in a location with any potential for corrosive gases. Larger VFDs with significant space or cooling requirements shall be located outside of MCCs.

The City requires VFD's with one or two Ethernet communications interfaces and supports star and ring network topologies. Where the VFD is installed in an MCC, use a single Ethernet connection to the VFD to facilitate easy removal of the MCC bucket without disturbing other networked devices. However, if the VFD is installed in a separate cabinet (not in an MCC), connect the VFD using a ring topology for better network fault tolerance.

Where a VFD is used with critical process equipment but equipment redundancy is not provided, it is recommended to provide a bypass starter in parallel with the VFD to allow for motor starting in the event of VFD failure. If a bypass starter is provided, it is recommended to also provide an isolation contactor upstream and downstream of the VFD to fully isolate the VFD from the circuit when starting from the bypass starter.

Typical network control and monitoring points for networked and hardwired low voltage VFDs are provided in Table 13-5-6 and Table 13-7-8, respectively.

Table 13-5-6: Low Voltage, Networked VFDs – Typical Control and Monitoring Points

Motor Size	Typical Control Points	Typical Monitoring Points
All motors	<ul style="list-style-type: none"> • Run command • Speed command • Reset command 	<ul style="list-style-type: none"> • Local/Remote, Hand/Off/Remote, or Manual/Off/Remote switch • Ready • Running • Motor speed • Motor current (3-phase average) • Accumulated run time • Last protection fault • Starts per hour • Out of service (e.g. a communication failure)

Notes:

1. Refer to the *Electrical Design Guide*, document 510276-0000-47ER-0001, for typical motor protection requirements, which should be monitored by the process control system.

Table 13-7-8: Low Voltage, Hardwired VFDs – Typical Control and Monitoring Points

Motor size	Typical Control Points	Typical Monitoring Points
All motors	<ul style="list-style-type: none"> • Run command • Speed command 	<ul style="list-style-type: none"> • Local/Remote, Hand/Off/Remote, or Manual/Off/Remote switch • Ready • Running • Motor speed • Motor current (3-phase average) • Accumulated run time • VFD faulted • Starts per hour

Notes:

1. Refer to the *Electrical Design Guide*, document 510276-0000-47ER-0001, for typical motor protection requirements, which should be monitored by the process control system.

13.2.4 Medium Voltage Motors

The City does not currently have an official standard for medium voltage motor controllers.

The typical control and monitoring points applicable to medium voltage motors are indicated in Table 13-9-10.

Table 13-9-10: Medium Voltage Motors – Typical Control and Monitoring Points

Motor size	Typical Control Points	Typical Monitoring Points
All motors	<ul style="list-style-type: none"> • Run command • Speed command (VFD applications only) 	<ul style="list-style-type: none"> • Local/Remote, Hand/Off/Remote, or Manual/Off/Remote switch • Ready • Running • Motor speed (VFD applications only) • 3-phase motor current • Accumulated run time • Starts per Hour

Notes:

1. Refer to the *Electrical Design Guide*, document 510276-0000-47ER-0001, for typical motor protection requirements, which should be monitored by the process control system.

13.2.5 Automatic Restart

Motor driven equipment that is controlled from the process control system shall be configured to restart after a delay following control system failure or a power failure event. Starting many motors at once can cause significant loading of the electrical distribution system and may cause unintentional tripping of circuit breakers.

The City's standardized PLC function blocks incorporate a timer to delay automatic restarting of motors. This functionality, along with the equipment restart delay, shall be specified in the project's functional requirements specification.

	Automation Design Guide	Revision: 03	Page 77 of 132
		Document Code: 612620-0013-40ER-0001	

14 VALVE CONTROL

14.1 General

Use electric actuators, as opposed to pneumatic actuators, where practicable for applications requiring power actuation of valves.

The type of electric actuator used is dependent on the type of valve. For small open/close valves that do not require position feedback, a solenoid actuator may be used. For applications requiring position feedback, electric motor-operated actuators shall be used.

The City has standardized on the use of Rotork quarter-turn and multi-turn electric valve actuators with an on-off torque requirement above approximately 250 Nm and modulating torques above approximately 150 Nm. Where actuators are required for these applications, specification of the valve actuators from the chosen manufacturer is mandatory for all new installations. For applications other than these, no standard currently exists.

Refer to Rotork Inc. documentation for actuator specifications and selection criteria. The valve actuator standardization was established through City of Winnipeg RFP 331-2014 and was awarded to:

Company: Rotork Inc.

Address: #6, 820 – 28th Street North East, Calgary, AB, T2A 6K1

14.2 Control and Monitoring

For solenoid operated valves, use hard-wired control from the PLC system in the form of a discrete output. Use an external interposing relay to energize the solenoid valve, rather than energizing the solenoid directly from the PLC output. Monitoring of valve position is typically not provided for solenoid operated valves.

Small electric actuators used for process or HVAC control are typically hardwired and controlled via discrete 120 Vac or analog 4-20 mA signals. Provide feedback to the control system as required.

HVAC damper actuators are typically hardwired, and position feedback to the controlling device is usually required for interlocking and/or alarming.

Electric actuators from Rotork Inc. may be ordered with a PROFIBUS communications interface. The decision to include a PROFIBUS interface on Rotork electric actuators is primarily based on the cost and application of the actuator. For small applications or applications where accuracy is not of great importance, it may be more cost effective and simpler to use hardwired control and monitoring. For larger valves, or where accuracy is of concern, use PROFIBUS communication.

The typical control and monitoring points for various valve actuator applications are provided in Table 14-1-2.

Table 14-1-2: Typical Valve Control and Monitoring Points

Valve and Actuator Characteristics	Typical Control Points	Typical Monitoring Points
Open/Close Valve, Solenoid Actuated, Hardwired	<ul style="list-style-type: none"> Open Command 	N/A
Small valves (≤ 102 mm), Open/Close, Electric Actuator, Hardwired	<ul style="list-style-type: none"> Open and Close Command 	<ul style="list-style-type: none"> Open and Closed Limit (as required)
Small valves (≤ 102 mm), Modulating, Electric Actuator, Hardwired	<ul style="list-style-type: none"> Position Command (4-20 mA) 	<ul style="list-style-type: none"> Position Feedback (4-20 mA)
Medium/Large (> 102 mm) Open/Close, Electric Actuator, Hardwired	<ul style="list-style-type: none"> Open Command Close Command 	<ul style="list-style-type: none"> Remote Selected Open Limit Closed Limit Fault
Medium/Large (> 102 mm) Modulating, Electric Actuator, Hardwired	<ul style="list-style-type: none"> Position Command (4-20 mA) Stop/Maintain Command 	<ul style="list-style-type: none"> Remote Selected Position Feedback (4-20 mA) Open Limit (optional) Closed Limit (optional) Fault
Open/Close Valve, Electric Actuator, PROFIBUS Communication (See Note 1)	<ul style="list-style-type: none"> Open command Close command 	<ul style="list-style-type: none"> Actuator Moving Closed Limit Open Limit Running Closed Running Open Remote Selected Local Stop Selected Local Selected Thermostat Tripped Monitor Relay Valve Obstructed Valve Jammed Valve Moving by Hand Moving Inhibited Position Control Enabled Watchdog Recovery Battery Low Control Contention

Valve and Actuator Characteristics	Typical Control Points	Typical Monitoring Points
Modulating Valve, Electric Actuator, PROFIBUS Communication (See Note 1)	<ul style="list-style-type: none"> Position command 	<ul style="list-style-type: none"> Valve Position Actuator Torque Actuator Moving Closed Limit Open Limit Running Closed Running Open Remote Selected Local Stop Selected Local Selected Thermostat Tripped Monitor Relay Valve Obstructed Valve Jammed Valve Moving by Hand Moving Inhibited Position Control Enabled Watchdog Recovery Battery Low Control Contention
On/Off Valve, Pneumatic Control	<ul style="list-style-type: none"> Open Command Close Command 	<ul style="list-style-type: none"> Closed Limit Open Limit
Modulating Valve, Pneumatic Control	<ul style="list-style-type: none"> Position Command 	<ul style="list-style-type: none"> Valve Position

Note:

1. *Not all of the monitoring points from PROFIBUS-connected valves are required to be displayed on the HMI system. Several of these monitoring points will be used in the control strategy only, or used in combination for indicating higher level alarms on the HMI.*

	Automation Design Guide	Revision: 03	Page 80 of 132
		Document Code: 612620-0013-40ER-0001	

15 SPECIFIC APPLICATION REQUIREMENTS

15.1 Building Mechanical Systems

1. All Building Mechanical systems shall be monitored and controlled by the plant PCS. An independent commercial-grade Building Management System (BMS) shall not be utilized.
2. All Building Mechanical control and monitoring shall be by PLC, consistent with the WSTP Automation Design Guide. No exceptions shall be permitted except for the following:
 - 2.1 Natural gas fired air handlers may utilize proprietary packaged controls for the natural gas burner and associated devices. However, the proprietary packaged controls shall not monitor or control any equipment or instrumentation outside of the air handler unit. Any liquid coils in the air handler shall be controlled by the PLC.
 - 2.2 Boilers and chillers may utilize packaged controls that do not fully comply with the WSTP Automation Design Guide. Ensure integration into the plant PCS is consistent with the Automation Design Guide and meets operational requirements.
 - 2.3 Small out-buildings with a ventilation rate of 100 L/s or less may utilize non-PLC based controls, provided the control is very basic. For example, a single unit heater may be controlled by a wall-mounted thermostat.
3. In situations where package HVAC controls are permitted in accordance with the above, the following requirements apply:
 - 3.1 Associated drawings shall clearly identify the wired devices and their locations.
 - 3.2 All interlocks shall be clearly documented for maintenance personnel.
 - 3.3 When an interlock is not met, there shall be a clear indication of the specific interlock not being met to maintenance personnel.
 - 3.4 As-built drawings shall be provided.
 - 3.5 Setpoint control of boilers, chillers, and air handling units shall be from the plant PCS via a coordinated interface.
 - 3.6 Alarms shall be provided from the package unit to the PCS.
4. Where possible and practical, utilize separate PLCs, dedicated to Building Mechanical systems rather than connecting to process-based PLCs. Note that all PLCs are part of a common PCS.

	Automation Design Guide	Revision: 03	Page 81 of 132
		Document Code: 612620-0013-40ER-0001	

16 INSTRUMENTATION

16.1 General Requirements

1. The instrumentation identified as requirements in this document shall not be construed as limiting the instrumentation requirements for a complete system that meets all requirements.
2. Unless specifically identified, all instrumentation shall be connected to the PCS with appropriate integration into control strategies and alarming.

16.2 Typical Practices

16.2.1 Fail-Safe Implementation

Where hardwired methods are used for connection of switches and/or relays used for alarming purposes, the switches and/or relays shall be wired in a fail-safe implementation, meaning that the switch is closed/relay coil is energized during normal operation and opens/releases upon an alarm condition.

Failure of any instrument shall cause the system to react in a way that will not cause damage to equipment, injury to personnel, or leave operation of equipment in an unsafe condition.

16.2.2 Routing of Signal Cabling

Where remote transmitters are used, careful consideration is required in the routing of the signal cabling between the sensor and transmitter, especially near high sources of noise such as VFD cabling. Signal cabling shall be designed to ensure that any interference is neutralized or mitigated, the use of dedicated conduits for such cabling is recommended.

16.2.3 Instrument Redundancy

Where failure or inaccuracy of a single instrument has unacceptable consequences, instrument redundancy shall be required. Instrument redundancy can be provided by either an identical instrument or an alternative (less expensive) instrument technology that provides an acceptable response.

Where instrument redundancy is provided for analog instruments (e.g. pressure transmitters), the process control system would typically operate on an average of the readings from the instruments. Selections should be provided on the HMI system to select which instrument(s) are actively used. For example, if two instruments are provided, the HMI would allow for selection of the first instrument, the second instrument, or an average of both instruments, for use by the control system.

While instrument redundancy may be provided using two instruments, it may be difficult to determine which of the two signals is correct if they do not match. For this reason, consider implementing triple redundancy for critical applications and implement a voting scheme in the PLC. Under this scenario, the PLC would compare the readings from all three instruments and if one signal did not match the other two then it would be ignored, and an alarm would be generated on the HMI system.

If an instrument in a redundant application fails, the process control system shall immediately ignore that instrument (i.e. not use it in the calculation of the average), and generate an alarm on the HMI system.

	Automation Design Guide	Revision: 03	Page 82 of 132
		Document Code: 612620-0013-40ER-0001	

16.2.4 Installation and Removal

Instruments shall not be mounted on equipment or piping subject to vibration.

Field instruments (unless in-line) shall be mounted on a 51 mm (2") hot dipped galvanized or aluminum pipe support (as appropriate for the location), or wall mounted. The instrument stands shall have a height of 1,500 mm to allow an easy access for process observation or maintenance. Where mounted on a catwalk/platform the preferred location shall be on the outside of the hand railing.

Removal of process instruments must be possible without stopping the process. This is achieved by installing appropriate isolation and/or bypass systems such as thermowells, valve manifolds, or software overrides.

16.2.5 Instrument Displays

Readings on instrument displays shall be in SI (metric) units and the units of measure shown shall match that specified in the project functional requirements specification.

16.2.6 Instrument Manifolds

All pressure instruments for process applications shall be supplied with block-and-bleed valves or three-way manifolds.

Differential pressure instruments for process applications shall be supplied with a five-way manifold.

16.2.7 Gas Detection Equipment

Fixed gas detection equipment shall be provided with a means for calibrating and testing the equipment at an accessible location. Some sensors need to be mounted on the ceiling or other readily inaccessible location, and as such will be difficult to access. Sensors shall be provided with means to attach 6 mm (1/4") I.D. stainless steel tubing, and the tubing shall be routed down to a location that is readily accessible to personnel and near the transmitter display.

Gas detection transmitters shall be provided with a local display and configured to indicate the gas concentration in units of % LEL.

A gas detection alarm shall be indicated with both a visual and audible alarm, where the visual alarm consists of a flashing red light.

16.2.8 Hazardous Location Door Entry Stations

Provide a door entry station at each door to a hazardous location where entry into the area is only permitted based on certain operating criteria. Examples include areas where the ventilation system is used to maintain a lower area classification, or a dual-rate ventilation system that must run at the high rate when the area is occupied by personnel.

The door entry station shall be equipped with coloured lights to indicate whether entry is permitted based on the information available to the control system. Provide a green light to indicate there are no known hazards (e.g. the ventilation system is running and no gas alarm is present, etc.), and that entry is therefore permitted. Provide a red "Do Not Enter" light to indicate that entry is not permitted due to ventilation system failure, the presence of a gas alarm, or other hazardous condition.

For dual-rate ventilation systems that operate at the high rate when occupied, provide a selector switch (or utilize the light switch) to allow personnel to switch to the high rate operation prior to entry. While the system is ramping up to the high ventilation rate, flash the red "Do Not Enter" light to indicate that this switch has been turned on but the system has not yet reached the high ventilation rate. Once the

	Automation Design Guide	Revision: 03	Page 83 of 132
		Document Code: 612620-0013-40ER-0001	

system has reached the high ventilation rate and no other hazards are known to exist then turn the red flashing light off and turn the green light on to signal that entry is permitted.

Note that in addition to door entry stations, an audible alarm should also be provided inside the area to alert personnel of a ventilation system failure.

16.3 Selection Criteria

16.3.1 Standardized Manufacturers

The City has standardized on Siemens electromagnetic flowmeters, ultrasonic level transmitters, RTD-based temperature transmitters, and pressure transmitters. This standardization was established under City of Winnipeg RFP 449-2014 and was awarded to:

Company: Trans-West Inc.
Address: 126 Bannister Rd., Winnipeg, MB, R2R 0S3

For gas detection equipment, the City has standardized on Mine Safety Appliance Company (MSA) equipment under City of Winnipeg RFP 123-2014, which was awarded to:

Company: MSA.
Address: 12134 – 154 Street NW, Edmonton, AB T5V 1J2

Refer to the City of Winnipeg Sewage Treatment Program standard specifications for additional details. Specification of instruments from the chosen manufacturer is mandatory for all new installations.

16.3.2 Instrument Accuracy

The accuracy of all instruments shall be better than the application requirements.

Instrument scales/ranges should be selected such that the normal operating point will be at approximately 50% of the full scale/range for pressure, temperature and density, and at 75% for flow rate and level. The design engineer should take a common-sense approach on systems that have large variability to ensure that instruments are operating at accurate points along their curve.

16.3.3 Transmitter Output

The preferred method to connect process instrument transmitters to the process control system is via a PROFIBUS network. PROFIBUS instruments have the advantage that they can be configured remotely, they can transmit one or more process variables to the process control system using a digital communication link, and can provide additional diagnostics information. Note, however, that PROFIBUS instruments typically are more expensive than traditional 4-20 mA-based instruments.

New analytical instruments, electromagnetic flowmeters, level transmitters, temperature transmitters, and pressure transmitters used for process applications should utilize a PROFIBUS output wherever possible. Some analytical instruments may be unavailable with a PROFIBUS output, in which case a Modbus/TCP output should be utilized instead. Replacement of existing 4-20 mA-based transmitters with PROFIBUS transmitters is not generally required during wastewater treatment plant upgrades, but this may be performed where desired. For non-process applications, such as an HVAC system, use of 4-20 mA output is generally preferred due to simplicity and cost.

Transmitters for process applications without a PROFIBUS output should incorporate a 4-20 mA output with HART protocol. Switches on process systems will typically be hardwired I/O. However, PROFIBUS should be considered if maintenance diagnostic information would be of value. Instruments used for HVAC applications shall be connected via hardwired methods, to minimize the cost of the instruments.

Use of DeviceNet, CANopen, or ControlNet instruments for new installations is not approved under any circumstance. Use of AS-i should be reviewed with the City prior to implementation.

Wireless instruments should generally not be used for process-related applications, but if they are required then select instruments that communicate using industry standard Wireless HART or ANSI/ISA 100.11a technology. Note that the wireless versions of Siemens instruments use Wireless HART. Install and connect an appropriate wireless gateway (or multiple gateways) to the associated Device Network for communication with the instruments. Wireless instruments should only be used where hard wiring is cost-prohibitive or infeasible, and only be used for non-critical monitoring applications. If use of wireless instruments is required for critical monitoring and control, employ redundant instruments and ensure that contingencies are in place to prevent process down-time resulting from wireless system failure. All wireless instrumentation applications shall be reviewed with and approved by the City prior to implementation.

16.3.4 Switches vs. Transmitters

The selection of discrete instruments compared with transmitters (either networked or not) should be considered in all cases. The primary advantages of switches over transmitters are simplicity and cost. Transmitters have the advantage that they can be part of an analog control scheme, such as PID control, and in the case of most PROFIBUS instruments, can be configured with internal alarm setpoints for use by the process control system. General application guidelines are provided in Table 16-1-2.

Table 16-1-2: Guidelines for Selection of Switches vs. Transmitters

Application	Instrument	Notes
Critical and safety applications	Consider Transmitter	Careful review is required. Codes may apply.
HVAC low temperature (Freeze-stat)	Switch	Simple, cost effective solution requiring hard-wired interlock.
Wet Well Level	Transmitter	Redundancy should be provided for control
Wet Well Low/High Level	Switch	Backup to level transmitter.
Room High Temperature	Transmitter	Can be used in control strategy as well.
Pump Low Flow Detection	Switch	Partial testing with pump on/off cycling provided.
	Transmitter	Where there is use as part of process measurement.
Ventilation Low Airflow Detection	Switch	On/off fans. Partial testing with fan on/off cycling provided.
	Transmitter	Variable speed fans
Instrument Air Low Pressure	Transmitter	Continuous indication of operation.

16.3.5 Instrument Power Supply

Instruments requiring external power should be powered from 24 Vdc unless it is not an option for a specific instrument, in which case 120 Vac would typically be used. For HVAC applications, 24 Vac is acceptable.

16.3.6 Materials

Materials for the wetted parts of all off-line instruments and instrument process connections shall be, as a minimum, 316 SS or per the corresponding piping specification and suitable for the handled process fluid.

Materials not in contact with the process fluid shall be suitable for the environment in which instruments are installed. In general, epoxy coated aluminum enclosures shall be used. For ingress protection requirements see Section 8.1. All instrumentation accessories and mounting hardware shall be stainless steel.

16.3.7 Flow Measurement Instruments

Electromagnetic flowmeters shall be used for measurement of the flow rate of liquids; however, consideration should be given to alternate technologies where requirements dictate.

Table 16-3-4 lists acceptable electromagnetic flowmeter liner materials for various types of media.

Table 16-3-4: Acceptable Electromagnetic Flowmeter Liner Materials

Media	Acceptable Liner Materials
Liquid Polymer	PFA, PTFE (Teflon), Ceramic
Water with up to 20 mg/l of organic solids, Chlorinated	PFA, PTFE (Teflon), Ceramic, EPDM, ETFE, Rubber – Ebonite.
Primary Clarifier Scum	PFA, PTFE (Teflon), Ceramic
Activated Sludge	PFA, PTFE (Teflon), Polyurethane, Neoprene.
Raw Sewage	PFA, PTFE (Teflon), Polyurethane, Neoprene.

Provide grounding rings for all electromagnetic flowmeter installations in accordance with the flowmeter manufacturer's recommendations for the specific application.

For all flow meter installations, ensure that the required upstream and downstream pipe diameters are met.

	Automation Design Guide	Revision: 03	Page 86 of 132
		Document Code: 612620-0013-40ER-0001	

16.3.8 Level Measurement Instruments

Where practicable, use ultrasonic level instruments for measurement of liquid level in process-related tanks and wet wells. Use of radar technology is to be avoided unless prior approval is obtained from the City.

Where ultrasonic level instruments are used for critical applications, provide discrete level switches (e.g. float switches) as a backup to the ultrasonic level instrument.

Use float switches for level control of small sump pits. The standard of acceptance is Flygt ENM-10 float switches for latched relay control and PIL-1 – PIL-15D for single float switch with hysteresis.

16.3.9 Pressure Measurement Instruments

The Siemens pressure transmitters may be used for measurement of gauge pressure, differential pressure, volumetric flow, liquid level, or liquid volume level.

16.3.10 Temperature Measurement Instruments

Field mounted RTDs are to connect to field mounted transmitters and be connected to the process control system via PROFIBUS or hardwired (4-20 mA) cabling. Use of PLC in-rack RTD input modules with direct connection to field mounted RTDs is not approved.

Use of thermocouples for temperature measurement in the wastewater treatment process is to be avoided; RTDs are to be used instead of thermocouples for process applications. Note that thermocouples may be required for non-process, high temperature applications. Use of thermocouples should be reviewed and approved by the City before being incorporated into a design.

All in-line sensors used for process and liquid temperature measurement instruments shall use thermowells. HVAC temperature measurement instruments in clean air typically do not require thermowells.

16.4 Application Requirements

16.4.1 HVAC – Air Systems

Provide instrumentation for HVAC filtration in accordance with Table 16-5. Connect all transmitters and switches to the PCS for monitoring, alarming, and control as applicable.

Table 16-5 : Filter Instrumentation

Application	Additional Criteria	Instrumentation Functions	PCS Functions (See Note 2)
Minimum Requirement if none of the below applies		PDG, PDSH (See Note 1)	PDAH
Systems serving electrically classified spaces		PDT, PDG	PDI, PDAH, PDAHH
Systems serving hazardous chemical spaces			
Systems where a plugged filter may impede human occupancy			
Filters on a media filtration system			
Systems with a design capacity $\geq 1,000$ L/s			

Notes:

- The instrumentation functions indicated may be integrated. Please reference the City Tag naming standard*
- The PCS functions are typical minimum requirements and are not exhaustive. For functions not defined submit to City for review and approval.*

Table 16-6 : Damper Instrumentation

Application	Additional Criteria	Instrumentation Functions	PCS Functions (See Note 2)
Motorized on/off damper		ZSC, ZSO	XC, ZLC, ZLO
Modulating damper		ZT	*C (See Note 3), ZI

Notes:

- The instrumentation functions indicated may be integrated. Please reference the City Tag naming standard*
- The PCS functions are typical minimum requirements and are not exhaustive. For functions not defined submit to City for review and approval.*
- The initiating variable for the damper depends on the application. Typical initiating variables are T and P.*

Table 16-7 : Air Flow Instrumentation

Application	Additional Criteria	Instrumentation Functions	PCS Functions (See Note 1)
Supply air – Electrically classified hazardous locations	Used to lower the electrical classification as per NFPA 820	FIT (See note 3)	FI, FAL, FALL, FAH, FAHH
	Design flow capacity \geq 500 l/s		
	Occupied at a frequency \geq 1 per month		
Exhaust air – Electrically classified hazardous locations	Used to lower the electrical classification as per NFPA 820		
	Design flow capacity \geq 500 l/s		
	Occupied at a frequency \geq 1 per month		
Supply air - unclassified location	Design flow capacity \geq 4000 l/s		
Exhaust air – unclassified location			
Return air - unclassified location			
Chemical- Under Development			

Notes:

1. *The PCS functions are typical minimum requirements and are not exhaustive. For functions not defined submit to City for review and approval. Designer/Integrator will create functions to meet the needs of the application*
2. *The flow rates indicated are the total flow for the system or space, whichever is greater.*
3. *Thermal dispersion type unless otherwise approved by the City.*

Table 16-8 : Pressure Instrumentation – HVAC Air Systems

Application	Additional Criteria	Instrumentation Functions	PCS Functions (See Note 1)
Room – Entire room is Class I, Zone 1		PDIT (See Note 2)	PDI, PDAL, PDALL, PDAH, PDAHH
Room – Entire room is Class I, Zone 2 and may contain partial Class I, Zone 1 areas	Area $\geq 100 \text{ m}^2$		
	Has an opening into a Class I, Zone 1 location (See Note 3)		
	Has an opening into an unclassified location (See Note 3)		
	Has two or more, or variable, ventilation rates		
Room – Contains Class I, Zone 2 area(s) but is not completely classified	Has an opening into a Class I, Zone 1 location (See Note 3)		
Room – Unclassified	Has an opening into a Class I, Zone 2 location (See Note 3)		
Any	Where a hazard could be introduced by a pressurization failure that would not be otherwise alarmed to the PCS.		

Notes:

1. *The PCS functions are typical minimum requirements and are not exhaustive. For functions not defined submit to City for review and approval. Designer/Integrator will create functions to meet the needs of the application*
2. *The room differential pressure will be measured relative to atmospheric pressure.*
3. *Openings include doors and openable windows, as well as process connection openings where there could be a Secondary grade of release as per IEC 60079-10-1.*

Table 16-9 : Temperature Instrumentation – HVAC Air Systems

Application	Additional Criteria	Instrumentation Functions	PCS Functions (See Note 2)
Coil – Heating or cooling with risk of freezing		TSL (See Note 3)	TAL
Outdoor air duct		TT	TI
Mixed air duct (outdoor air and return air)		TT	TI, TAL, TAH
Reheat air duct (After heat recovery or initial heating unit / coil)		TT	TI, TAL, TAH
Supply air duct		TT	TI, TAL, TALL, TAH, TAHH
Room < 10 m ² and routinely occupied (See Note 4)		TT	TI, TAL, TALL, TAH, TAHH
Room ≥ 10 m ²			
Room with different zones or temperature profiles during normal or abnormal operation		Multiple TT as required.	

Notes:

1. *The instrumentation functions indicated may be integrated.*
2. *The PCS functions are typical minimum requirements and are not exhaustive. For functions not defined submit to City for review and approval. Designer/Integrator will create functions to meet the needs of the application*
3. *Hardwire interlock the low temperature switch with the supply air fan and other equipment as required.*
4. *Control rooms require temperature transmitters.*

Table 16-10 : Valve Instrumentation

Application	Instrumentation Functions	PCS Functions (See Note 2)
Motorized on/off valve	ZSC, ZSO	XC, ZLC, ZLO
Modulating valve	ZT	*C (See Note 3), ZI

Notes:

1. *The instrumentation functions indicated may be integrated.*
2. *The PCS functions are typical minimum requirements and are not exhaustive. For functions not defined submit to City for review and approval. Designer/Integrator will create functions to meet the needs of the application*
3. *The initiating variable for the damper depends on the application. Typical initiating variables are T.*

Table 16-11 : Miscellaneous Instrumentation

Application	Instrumentation Functions	PCS Functions (See Note 2)
Motorized on/off valve	ZSC, ZSO	XC, ZLC, ZLO
Modulating valve	ZT	*C (See Note 3), ZI

Notes:

4. *The instrumentation functions indicated may be integrated.*
5. *The PCS functions are typical minimum requirements and are not exhaustive. For functions not defined submit to City for review and approval. Designer/Integrator will create functions to meet the needs of the application*
6. *The initiating variable for the damper depends on the application. Typical initiating variables are T.*

16.4.2 Building Sumps (Non-Process)

1. Sumps with potentially significant flows of water that could present a flooding situation in the event of an instrument / control failure shall be provided with a secondary failsafe activation device. This instrument may be in common with the high sump level alarm instrument.
2. Provide a high-level sensor for all sumps, connected to the PCS for alarming. The high-level sensor shall be independent of the level instrumentation for primary pump control. Acceptable product types are:
 - 2.1 Flygt ball;
 - 2.2 Rod-based float switch; and
 - 2.3 Capacitance probe.
3. Provide ultrasonic-based instrumentation for pump control for sump pumps. Provide a stilling chamber as required.

16.4.3 Gas Detection

1. General Requirements
 - 1.1 Provide a sufficient quantity of gas detection systems to adequately cover the entire space that is or may be occupied. Do not assume that a single gas detection sensor is sufficient to cover an entire room or space.
 - 1.2 Ensure gas detection systems are located appropriately to detect hazardous gases within the coverage area. Review ventilation flow patterns and locate the sensors appropriately. For example, it is not appropriate to locate a gas detection sensor adjacent to a supply air grille.
 - 1.3 Locate gas detection systems at the appropriate elevation, considering the toxic or hazardous gas density, ventilation patterns, and location of personnel.
 - 1.4 Utilize continuous sample draw based gas detection systems for:
 - 16.4.3.1.4.1 Locations where access is difficult, or there is significant impediment to occupancy; and
 - 16.4.3.1.4.2 Applications where pre-conditioning of the sample is required to provide sample accuracy or extended sensor life.

	Automation Design Guide	Revision: 03	Page 92 of 132
		Document Code: 612620-0013-40ER-0001	

- 1.5 Where a dual-rate ventilation system is provided, interlock the gas detection with the ventilation system to ensure that a high-rate of ventilation is provided upon detection of a hazardous gas.
 - 1.6 Ensure provision of detected gas levels to plant PCS (Profibus preferred). The only exception is that carbon monoxide sensors may simply transmit a discrete alarm to the plant PCS.
 - 1.7 Provide means to calibrate all gas detection instruments without the use of temporary ladders, scaffolding, etc. This may require provision of remote calibration systems.
 - 1.8 Provide visual and audible alarms in accordance with the Automation Design Guide. Ensure alarms are configured with setpoints that protect personnel from exceeding exposure limits; however, extraneous alarms shall be avoided while the space is unoccupied.
2. For H₂S gas detection:
 - 2.1 Provide sensors capable of monitoring H₂S levels as low as 1 ppm.
 3. For combustible gas detection:
 - 3.1 Utilize long-life infrared-based detectors wherever possible.
 - 3.2 Provide alarming upon gas levels that equal or exceed 5% of the lower explosive limit.
 - 3.3 Where spaces have more than one rate of ventilation, interlock gas detection with ventilation / odour control systems to set ventilation at the highest level upon combustible gas levels that equal or exceed 10 percent of the lower explosive limit.
 - 3.4 Where gas detection systems are provided, ensure that a hardwired interlock is provided to engage the high-rate of ventilation (if provided). In addition to the ventilation interlock, all gas detection systems shall provide the current detected gas level to the PCS, except that this requirement is not mandatory for carbon monoxide sensors. (Compare with above)
 - 3.5

16.4.4 Permanent Gas Detection

1. Provide permanent fixed gas detection for hazardous and toxic substances as follows:
 - 1.1 In accordance with Table 16-12;
 - 1.2 Carbon Monoxide (CO) sensors in all locations where direct gas-fired equipment is utilized;
 - 1.3 Oxygen deficiency sensors in all locations where there is an oxygen displacement risk, including all spaces with a floor elevation 10 meters or more below grade;
 - 1.4 As required by codes and regulations; and
 - 1.5 As appropriate based upon Good Industry Practice.
2. Provide permanent fixed gas detection for combustible gasses as follows:
 - 2.1 In accordance with NFPA 820;
 - 2.2 As required by codes and regulations; and
 - 2.3 As appropriate based upon Good Industry Practice.

Table 16-12: Permanent Gas Detection of Toxic and Hazardous Substance - Minimum Requirements

Occupancy (See Note 1)	Normal Concentration (See Note 2)	Expected Abnormal Concentration (See Note 3)	Permanent Gas Detection Required
< 1 per year	Any	Any	No
≥ 1 per year AND < 1 per week	< TLV-TWA	Any	No
	≥ TLV-TWA	Any	Yes
≥ 1 per week AND < 1 per day	< TLV-TWA	< TLV-STEEL	No
		≥ TLV-STEEL	Yes
	≥ TLV-TWA	Any	Yes
≥ 1 per day	< TLV-TWA	< TLV-TWA	No
		≥ TLV-TWA	Yes
	≥ TLV-TWA	Any	See Note 4

Note(s):

1. *The Occupancy includes any period of occupancy by any personnel, of any duration.*
 2. *The Normal Concentration includes both periods of occupancy and non-occupancy.*
 3. *The Expected Abnormal Concentration is based upon the failure of any equipment or component.*
 4. *Not acceptable as per exposure limits*
3. Comply with code and functional specification regarding implementation of gas detection controls.

16.4.5 Chemical Rooms

- 1.1 High speed ventilation shall be triggered by a local push button manually outside of the entrance of chemical areas to activate the emergency exhaust fans and supply fans.
- 1.2 High speed ventilation shall be triggered by the gas or spill detection if available.

16.4.6 Smoke Detectors

1. Provide duct smoke detectors only where required by the National Building Code or local code requirements.

16.4.7 Security

Table 16-13 : Door Monitoring

Application	Additional Criteria	Instrumentation Functions	PCS Functions (See Note 1)
Door is between an unclassified location and a Class I, Zone 2 location		ZSC (See Note 2)	ZAO (Typically with time delay)
Door is between a Class I, Zone 2 location and a Class I, Zone 1 location			

Notes:

1. *The PCS functions are typical minimum requirements and are not exhaustive. For functions not defined submit to City for review and approval.*
2. *Ensure door switch is rated for the higher electrical classification.*

	Automation Design Guide	Revision: 03	Page 95 of 132
		Document Code: 612620-0013-40ER-0001	

17 POWER SUPPLY

17.1 General Requirements

Provide redundant 24 Vdc power supplies for all PLC system installations. Where the power supplies are associated with a PLC installation that replaced an existing DCS PCU, the 24 Vdc power supplies may be located inside the existing DCS cabinet. For PLC installations not meant to replace an existing DCS PCU, provide a separate “power supply panel” containing the redundant 24 Vdc power supplies.

Provide power supply panels to supply 24 Vdc power to neighbouring control panels, networking panels, and other process control system panels or devices that require 24 Vdc power. These panels are to be fed from UPS/Utility 120Vac Feeds with redundant 120Vac to 24Vdc power supplies and Redundancy module

Remote I/O panels in the field may contain 24 Vdc power supplies if they are not in close proximity to a power supply panel.

17.2 24 Vdc Power Supplies

Where a facility is equipped with an instrumentation ground, connect the common terminal on the output of each 24 Vdc power supply to the instrumentation ground. Otherwise, connect the common terminal of each 24 Vdc power supply to the electrical (safety) ground.

Provide monitoring of the 24 Vdc power supplies by the process control system via the dry contact outputs on the power supplies and/or redundancy module.

Power each 24 Vdc power supply from a separate 120 Vac source to improve availability. Power the first power supply from a 120 Vac UPS panelboard (i.e. a panelboard that is powered from a UPS), and the second power supply from a 120 Vac non-UPS panelboard (i.e. a panelboard that is not fed from a UPS, which may or may not have standby generator backup).

Provide individual fusing within power supply panels for each connected load. A fuse schedule shall be shown on the power distribution schematics, showing the fuse type and rating for each fuse.

Indicate the 24 Vdc power supply loading on the power supply distribution schematics so that it is clear how much spare capacity is available for future loads.

Power supplies should be redundant.

module when loads can only support a single input.

17.3 UPS Power

Critical automation equipment shall be powered from an uninterruptible power supply, either directly from a small individual UPS, or from a UPS panelboard. The decision to use a small individual UPS is appropriate where the number of UPS loads within a given physical area is limited and/or widely distributed. For remote locations it is often more appropriate to install a small individual or distributed UPS rather than extend UPS from a large centralized UPS. Typically, UPS power in a wastewater treatment facility will be centralized with distribution through a dedicated panelboard. Where small individual UPS units are used, the UPS shall be industrial-grade rather than commercial-grade. Direct current (dc) UPS units with a 24 Vdc output are acceptable for small loads, such as a single control panel.

For the most critical systems and where standby generation is not available, consideration should be given to utilization of two UPS systems with separate power supplies and separate distribution, feeding loads that are dual sourced (e.g. computer servers with dual power supplies). Note that the use of

paralleled UPS units with a synchronized common distribution system is not a preferred redundancy solution.

Table 17-1-2 indicates the requirement for UPS power for various types of process control system equipment.

Table 17-1-2: Equipment Requiring UPS Power

Equipment	UPS Powered
HMI Servers	Yes
Historian Servers	Yes
HMI Operator Workstations and Monitors	Yes
Process Related Network Equipment	Yes
HMI Touchscreens, Field Mounted	Yes
Process Related PLCs and I/O	Yes
Non-Process Related PLCs and I/O	Yes
Process Related Instruments	Yes
Non-Process Related Instruments with exception to emergency requirements related to security, HVAC and gas detection.	Optional
Emergency Shutdown Systems	Yes
Programming/Maintenance Workstations and Monitors	Yes

The design battery duration rating of the UPS is dependent on the criticality of the load and degree of backup within the power supply system. Battery run time calculations shall be performed for all designs.

Table 17-3-4: UPS Design Battery Life

UPS Type	Backup Generator	Time	
		Low / Medium Reliability Requirement	High Reliability Requirement
Centralized (Large)	None	60 minute	120 minute
	Single Standby	30 minute	60 minute
	Redundant Standby	15 minute	30 minute
Distributed (Small, Individual)	None	45 minute	120 minute
	Single Standby	20 minute	60 minute
	Redundant Standby	10 minute	30 minute

Motor starters within MCCs will be powered by dedicated local 120 Vac control power transformers associated with each motor starter. Ensure that manual control capability, where provided, is not compromised due to the loss of any other power source, including the loss of UPS power.

	Automation Design Guide	Revision: 03	Page 97 of 132
		Document Code: 612620-0013-40ER-0001	

18 HAZARDOUS LOCATIONS

18.1 General

Wastewater facilities typically have some hazardous locations due to the presence of combustible gas and liquids (Zone 0/1/2, previously known as Class I). Hazardous locations due to presence of combustible dust (Zone 20/21/22, previously known as Class II), or fibres or filings (Zone 20/21/22, previously known as Class III) are generally not found within wastewater treatment facilities.

Design, installation, selection of equipment and materials shall be based on the hazardous location drawings produced for the facility.

18.2 References

All installations shall comply with the latest codes regarding installations associated with hazardous locations, including but not limited to:

1. CSA C22.1, Section 18 – Hazardous locations.
2. CSA C22.1, Appendix F – Recommended installation practice for intrinsically safe and non-incendive electrical equipment and wiring.
3. Winnipeg Electrical Bylaw.

Use the following standards, along with sound engineering judgement, in the design of automation equipment installations associated with hazardous locations:

1. Definitions and Information Pertaining to Electrical Equipment in Hazardous (Classified) Locations, ANSI/ISA-12.01.01-2013.
2. Recommendations for the Preparation, Content, and Organization of Intrinsic Safety Control Drawings, ANSI/ISA-12.02.02-2014.
3. Recommended Practice for Wiring Methods for Hazardous (Classified) Locations, Instrumentation Part 1: Intrinsic Safety, ANSI/ISA-RP12.06.01.
4. NFPA 820.

Equipment associated with hazardous locations shall meet the applicable codes as follows:

1. Explosion proof enclosures used within hazardous (classified) locations shall meet CSA C22.2, No. 30.
2. Motors and generators used within hazardous (classified) locations shall meet CSA C22.2, No. 145.
3. Combustible gas detection equipment used within hazardous (classified) locations shall meet CSA C22.2, No. 152.
4. Intrinsically safe equipment used for hazardous (classified) locations shall meet CSA C22.2, No. 157.
5. Cables and cable glands used within hazardous (classified) locations shall meet CSA C22.2, No. 174.
6. Non-incendive electrical equipment installed within Class I, Division 2 hazardous (classified) locations shall meet CSA C22.2, No. 213.

MTL TP1121-1, A definitive guide to earthing and bonding in hazardous areas, may also be used.

	Automation Design Guide	Revision: 03	Page 98 of 132
		Document Code: 612620-0013-40ER-0001	

18.3 Design Requirements

18.3.1 General

All equipment shall have the appropriate Class, Division or Zone, Group, and Temperature Class ratings for the area in which they are installed. Exceptions to this include simple apparatus, which are field devices that will neither generate nor store more than 1.2 Volts, 0.1 Amps, 25 mW, or 20 μ J. Examples of simple apparatus include simple contacts, thermocouples, RTDs, LEDs, and non-inductive potentiometers and resistors.

18.3.2 Intrinsically Safe Systems

An intrinsically safe (IS) circuit is one which is incapable of causing ignition of the prescribed flammable gas, vapour, or dust upon the occurrence of any spark or thermal effect during normal use, or any conditions of fault likely to occur in practice.

An intrinsically safe system generally consists of three components:

1. The field device, referred to as the intrinsically safe apparatus,
2. The field cabling, and
3. The energy limiting device or barrier, referred to as the intrinsically safe associated apparatus.

For all designs incorporating intrinsically safe systems, the designer shall perform all entity parameter calculations to ensure that the complete installation meets the requirements of the intrinsically safe apparatus and associated apparatus, and is a safe installation. Specific manufacturers and model numbers, and the entity parameters, shall be indicated on the associated loop drawing.

Where associated apparatus are used, they shall be located as close as possible to the hazardous area to minimize cable length, thereby minimizing capacitance in the circuit.

Grounded associated apparatus that contain one or more shunt diode devices (e.g. Zener diodes) shall be grounded to a ground electrode and have a ground path resistance to the grounding electrode of less than 1 Ohm. Where it is not possible to achieve a ground path resistance of less than 1 Ohm, consideration should be given to using isolated repeater barriers, which do not require grounding, as opposed to the grounded type.

Where grounded associated apparatus are used, duplicate grounding conductors shall be provided to connect the associated apparatus to the designated ground electrode. The grounding conductors shall be minimum 12 AWG each. The grounding system shall be insulated from ground at all places except at the point of connection to the designated ground electrode.

Grounded associated apparatus may be connected directly to a ground electrode, but if multiple grounded associated apparatus are used then it is often beneficial to install intermediary grounding points (e.g. copper bus bars) to reduce the number of individual grounded conductors.

Where multiple grounded associated apparatus are installed in an enclosure, provide a copper barrier bus within the enclosure for grounding each barrier. Ground each barrier to the barrier bus using duplicate 12 AWG, insulated conductors.

Where multiple enclosures containing grounded associated apparatus are installed in the field, an IS master ground bus bar may also be provided in the building for grounding the enclosures. Installing an IS master ground bus also facilitates grounding of new IS enclosures that may be added in the future. Where an IS master ground bus bar is employed, it shall be isolated from structural steel and connected directly to the building star ground or electrode ground, or as close as practicable. Provide duplicate bonding connections between the IS enclosures and the IS master ground bus using larger, insulated

	Automation Design Guide	Revision: 03	Page 99 of 132
		Document Code: 612620-0013-40ER-0001	

conductors, such as with two (2) 4 AWG or 6 AWG conductors. Provide duplicate grounding conductors between the IS master ground bus and the final grounding connection using two (2) insulated copper conductors that are at minimum 2/0 AWG each. As previously stated, the ground path resistance between any grounded associated apparatus and the ground electrode shall be less than 1 Ohm.

All bonding and grounding connections shall be secure, permanent, visible, and accessible for routine inspection.

Refer to Section 20 for additional information on grounding.

Review the recommended practices for bonding of cable shields indicated in ANSI/ISA-RP12.06.01.

18.4 Preferred Methods of Protection

18.4.1 General

If possible, avoid locating equipment in hazardous locations to eliminate the additional installation requirements associated with hazardous locations. Where equipment must be located in a hazardous area, the preferred method of protection depends on the classification of the area.

Equipment utilizing isolation techniques such as pressurization, purging, and continuous dilution generally require frequent maintenance and inspections. For this reason, pressurization, purging, and continuous dilution shall only be used if they are deemed the only option for protection.

The preferred methods of protection are provided in the following sections.

18.4.2 Zone 0 Locations

The preferred method of protection in Zone 0 (previously known as Class I, Zone 0) locations is the intrinsically safe “ia” method.

18.4.3 Zone 1 Locations

The preferred method of protection in Zone 1 (previously known as Class I, Zone 1) locations is the intrinsically safe “ia” or “ib” method as this is typically the lowest cost solution and allows live work to be done in the hazardous area. If the intrinsically safe method is not an option, then the flameproof (d) method is preferred. Other methods may be acceptable but should be discussed with the City before use.

18.4.4 Zone 2 Locations

The preferred method of protection in Zone 2 (previously known as Class I, Zone 2) locations is the non-sparking, non-arcing “n” method as this is typically the lowest cost solution and allows for the simplest installation. If this method is not an option then the intrinsically safe “ia” or “ib” method or the flameproof “d” method is preferred. Other methods may be acceptable but should be discussed with the City before use.

	Automation Design Guide	Revision: 03	Page 100 of 132
		Document Code: 612620-0013-40ER-0001	

19 SAFETY INSTRUMENTED SYSTEMS

19.1 General

A Safety Instrumented System (SIS) is engineered to perform safety function(s) that are intended to achieve or maintain a safe state for the equipment under control, in respect of a specific hazardous event. Examples of safety functions include functions that are required to be carried out as positive actions to avoid hazardous situations (for example switching off a motor) and functions that prevent actions being taken (for example preventing a motor starting).

A safety instrumented system is required when, after performing a Hazard and Risk analysis, the risk reduction provided by external risk reduction and other technology-based systems is not enough to meet the target risk. External risk reduction examples include shielding, emergency management and containment system. Other technology-based systems include relief valves and credible basic process control system functions.

Each “external risk reduction” and “other technology” can be credited with risk reduction as an independent protection layer if:

1. They are effective in preventing the consequence,
2. They are independent of the initiated event,
3. They are independent of other credited independent protection layers for a given scenario, and
4. They can be audited.

After all of the risk reduction and mitigation impacts from the basic process control system and other layers of protection are considered, a user must compare the residual risk against their risk tolerance. If there is still an unacceptably high level of risk, a Risk Reduction Factor (RRF) is determined and a Safety Integrity Level (SIL) requirement is calculated. The RRF is the inverse of the Probability of Failure on Demand for the Safety Instrumented Function (SIF). A multidisciplinary approach is usually required to determine SIL and SIF.

Safety Integrity Level (SIL) is a discrete level (one out of a possible four), corresponding to a range of safety integrity values, where SIL 4 has the highest level of safety integrity and SIL 1 has the lowest.

A Safety Integrity Level (SIL) is not a property of a system, subsystem, element or component. The correct interpretation of the phrase “SIL n safety-related system” (where n is 1, 2, 3 or 4) is that the system is potentially capable of supporting safety functions with a safety integrity level up to n.

Safety integrity levels are used for specifying the safety integrity requirements of the safety functions to be allocated to the safety systems.

When a SIL 1 or higher electrical/electronic/programmable electronic safety related system is required, the design, implementation, and commissioning, and all documentation deliverables shall comply with ANSI/ISA-84.00.01-2001 (IEC 61511-1 Mod).

The process and documentation must be carried out with the participation of a functional safety engineer, F.S. Eng. (TÜV Rheinland).

In general, the requirement for design and implementation of safety instrumented systems would be identified in the project scope of work.

	Automation Design Guide	Revision: 03	Page 101 of 132
		Document Code: 612620-0013-40ER-0001	

19.2 Documentation Requirements

Documentation deliverables shall be provided for all safety instrumented systems and shall include at minimum the following:

1. Indication of the hazards or hazardous events that are being mitigated and associated probability and consequences of the events occurring.
2. The allocation of safety functions to protection layers.
3. Indication of the safety target, safety functions required, and the tolerable risk.
4. Identification of the external risk reduction facilities, if any.
5. Identification of applicable regulatory requirements, if any.
6. The safety requirements specification, including the functional requirements and safety integrity requirements of the safety instrumented system, and its required safety integrity level.
7. The type of safety function of the safety instrumented system, be it continuous mode or demand mode, and for the demand mode case whether the system is used for prevention functions or mitigation functions.
8. Sealed engineered drawings indicating the make and model number of each hardware and software component used in the design, and allowable substitutions where applicable.
9. The safety instrument system supporting data (e.g. hardware MTBF, etc.)
10. Requirements for the installation, testing, and commissioning of the safety instrumented system. A complete and detailed commissioning procedure shall be provided.
11. Required routine testing and maintenance procedures of the implemented safety instrumented system, including identification of department(s) involved and qualifications or certifications required.
12. Identification of the stages in the safety lifecycle at which point additional functional safety assessment activities are to be carried out. (e.g. after changes to the associated process system or upon identification of new hazards not previously considered, etc.)
13. Decommissioning procedures of the safety instrumented system.
14. Certifications of the safety instrumented system designer.

All documentation provided shall be accurate, easy to understand, suit the purpose for which it is intended, and be available in an accessible and maintainable form. Each piece of documentation shall have unique identification so it is possible to reference, shall have a revision index to allow for identification of different revisions, and be structured to make it possible to search for relevant information.

All documentation shall be revised, amended, reviewed, approved, and be under the control of an appropriate documentation control scheme.

19.3 General Design Principles

The SIS shall be separate from the basic process control system (BPCS) to ensure that a failure of a single device does not corrupt the control function and interlock system.

The SIS shall not be used for basic process control where a failure of the SIS results in a failure of basic process control function and places demand on the SIS.

Where an SIS is used for both safety and non-safety functions then all hardware and software that can negatively affect any safety instrumented function, under any condition, shall be treated as part of the SIS and comply with the requirements for the highest SIL.

	Automation Design Guide	Revision: 03	Page 102 of 132
		Document Code: 612620-0013-40ER-0001	

Where an SIS is used to implemented safety instrumented functions at various safety integrity levels, the shared components shall meet the highest safety integrity level.

Methods for performing maintenance and testing shall be incorporated into the design of all safety instrumented systems.

The design of the SIS shall account for human capabilities and limitations and be suitable for the related tasks assigned to operators and maintenance personnel.

The SIS shall be designed in such a way that once it has placed the process in a safe state that the process shall remain in a safe state until a manually initiated reset is performed, unless otherwise dictated by the requirements of the system.

Manual means shall be provided to actuate the SIS final elements, unless otherwise dictated by the requirements of the system.

Safety instrumented functions with a safety integrity level higher than that associated with SIL 4 shall not be allocated to a safety instrumented system.

Applications which require the use of a single safety instrumented function of safety integrity level 4 are rare in the process industry, and such applications shall be avoided where reasonably practicable because of the difficulty of achieving and maintaining such high levels of performance throughout the safety life cycle. If analysis results in a SIL 4 being assigned to a safety instrumented function, the process design shall be changed in a way that makes it more safe or additional layers of protection shall be added. These changes could perhaps then reduce SIL requirements for the safety instrumented system.

Components as part of the SIS for SIL 1 to SIL 3 shall be either in accordance with IEC 61508 or shall meet the minimum requirements for hardware fault tolerance and be suitable based on prior use as per that defined in ANSI/ISA-84.00.01-2004.

Design and implement safety instrumented systems such that they are not likely to experience common cause failure, which is the result of one or more events ultimately leading to system failure.

Design all safety instrumented systems in a fail-safe manner such that failure of the system results in a safe and orderly shutdown or mode of operation of the associated process equipment.

Field devices shall be selected and installed in a manner so as to minimize failures or inaccuracies. This includes but is not limited to affects due to process or environmental conditions such as corrosion, freezing, high temperature and pressures, suspended solids, and condensation.

Each field device shall have its own dedicated wiring to the system inputs/outputs, except where sensors are wired in series or multiple final elements are connected to a single output.

	Automation Design Guide	Revision: 03	Page 103 of 132
		Document Code: 612620-0013-40ER-0001	

20 GROUNDING

20.1 General

Automation equipment is generally more sensitive to noise and voltage spikes on the grounding system than electrical equipment such as MCCs, VFDs, and motors. For this reason, grounding of automation equipment often requires extra care to ensure the equipment does not fail as a result of continuous or momentary issues on the grounding system.

Automation equipment that is powered from a 120 Vac supply shall have the enclosure or chassis bonded to the electrical (safety) grounding system. This is to allow ground fault currents that are sourced from the 120 Vac supply to return to the source, which would trip the protective device (fuse or circuit breaker) feeding the equipment. Automation equipment that is powered from 24 Vdc and below should be connected to an isolated instrumentation ground, which is segregated from the electrical (safety) ground to the greatest extent possible. As discussed in Section 12.7, if automation equipment is powered from 120 Vac and also contains PLC I/O, 24 Vdc power supplies, or shielded network cabling, the equipment shall be provided with both an electrical (safety) ground for grounding the enclosure, and an isolated instrumentation ground for grounding the 24 Vdc common and the cable shields.

The grounded conductor associated with an isolated instrumentation ground should be connected as close as possible to a ground electrode so that noise and voltage spikes, as seen by the automation equipment, are kept to a minimum. If multiple pieces of automation equipment are being installed, it is typically not cost effective to install dedicated ground conductors between each piece of automation equipment and the ground electrode. Instead, it is more sensible to install an automation equipment grounding point (e.g. an isolated ground bus bar within an automation room), which allows for bonding multiple pieces of automation equipment to ground. The grounding point would be connected as close as practicable to a ground electrode with a single, insulated conductor. Where automation equipment grounding points are provided, they shall be isolated from building structural steel.

As per the electrical code, separate grounding systems may not be provided for a single building and therefore the automation grounds are not completely independent from the electrical (safety) ground, but are segregated to the greatest extent possible. The only common point of connection should be at the final connection point to the grounding system, near a ground electrode.

If only one or two PLCs or HMI clients are being installed in a building, installation of a dedicated automation ground would generally not be required due to the additional costs involved. In this case, the equipment may be connected to the electrical (safety) ground system if deemed acceptable.

Further discussion on the implementation of automation equipment grounding is provided in Section 20.2.

20.2 Implementation of Automation Equipment Grounding

20.2.1 Installations in Existing Buildings

The existing wastewater treatment facilities typically employ a single electrical (safety) ground within each building, and dedicated grounding points for automation equipment may or may not be provided.

Where new automation equipment is installed into an existing building with only an electrical (safety) ground, and it is not within the scope of work to provide dedicated automation grounding points, the automation equipment should be bonded as close as practicable to an existing ground electrode.

If a significant amount of new automation equipment is being installed into a building, new automation grounding points (e.g. isolated ground bus bars) should be installed for bonding the new automation

	Automation Design Guide	Revision: 03	Page 104 of 132
		Document Code: 612620-0013-40ER-0001	

equipment to ground. Multiple automation grounding points may be provided for serving equipment in separate areas of the building to minimize cable length, or for serving different types of automation equipment.

20.2.2 Installations in New Buildings

New buildings shall be constructed with dedicated automation grounding points. Multiple automation grounding points should be provided for serving equipment in separate areas of the building to minimize cable length, or for serving different types of automation equipment as required.

20.2.3 Typical Configurations

A typical building ground system is composed of two or more ground electrodes in close proximity, or a building perimeter ground with several ground electrodes distributed at regular intervals. When connecting automation equipment to a ground electrode, it is preferred to use an electrode that is not directly used by the electrical (safety) ground in order to reduce the potential rise, as seen by the automation equipment, during an electrical ground fault.

Insulated, 2/0 AWG conductors are typically used to ground equipment grounding points (e.g. ground bus bars) to ground. Intrinsically safe grounding points and electrical (safety) grounding points are grounded using duplicate grounding conductors for redundancy.

Typical grounding system implementations are provided in the following figures. Figure 20-1 illustrates a grounding system with three ground rods in close proximity, and the preferred method to connect the electrical and automation grounding points to the ground rods. Figure 20-2 illustrates a grounding system using a perimeter ground, with ground rods distributed at regular intervals, and the preferred method to connect the electrical and automation grounding points to the perimeter ground cabling.

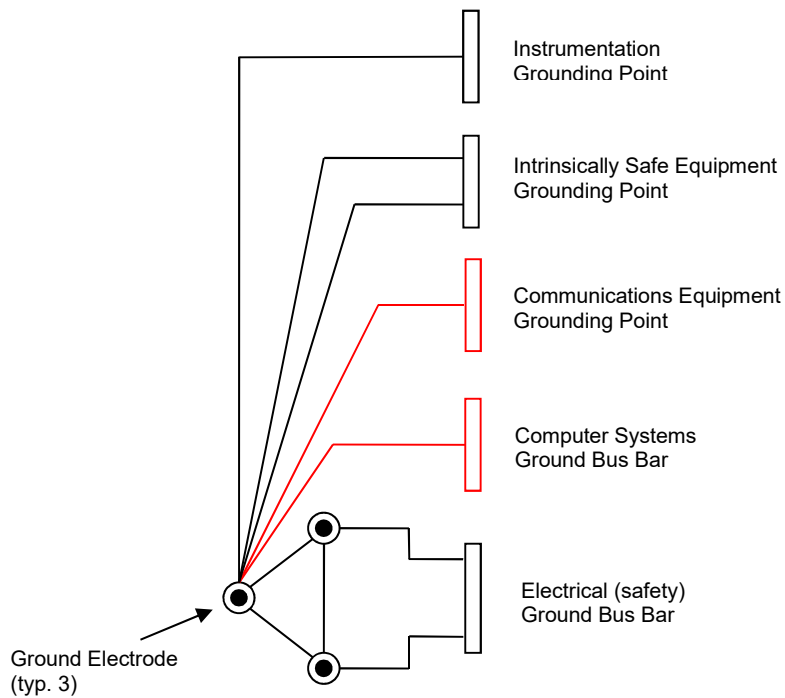

Figure 20-1: Typical Grounding System Implementation with Three Grounding Electrodes

Notes:

1. *The electrical (safety) ground bus bar is grounded to two ground electrodes to ensure proper connectivity to ground.*
2. *The instrumentation and intrinsically safe ground bus bars are grounded to a different ground electrode than those used by the electrical (safety) ground. This is done to minimize potential rise on these ground buses during an electrical ground fault. The negative effects resulting from electrical noise are also minimized.*
3. *Duplicate grounded conductors are provided for the Intrinsically Safe ground bus bar for safety reasons.*

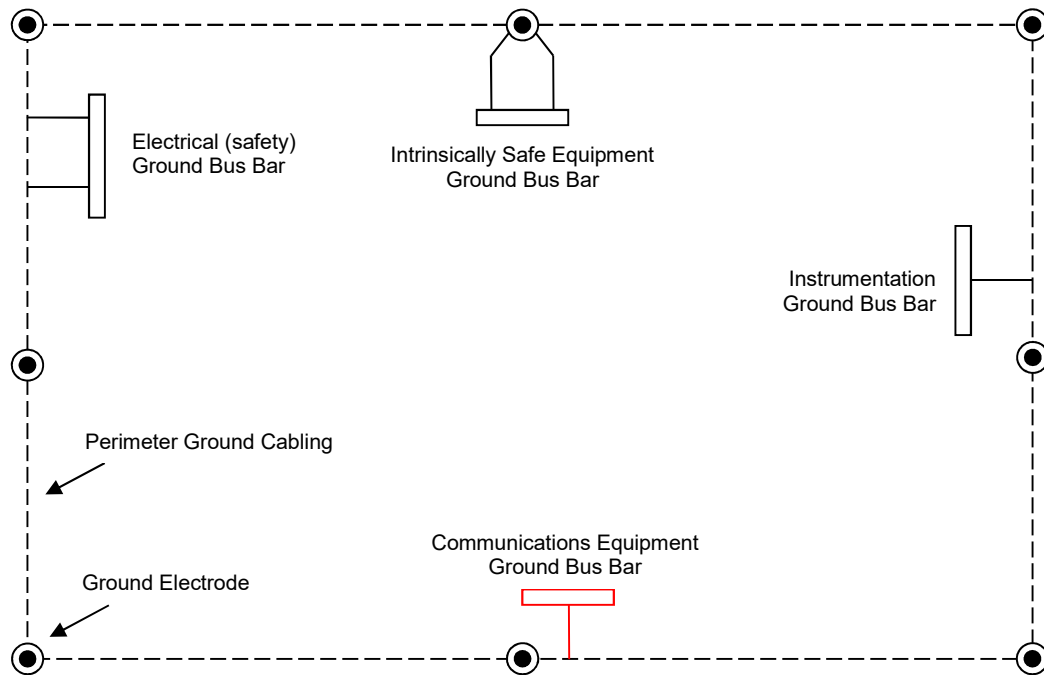

Figure 20-2: Typical Grounding System Implementation with a Perimeter Ground

Notes:

1. The electrical (safety) ground bus bar is grounded using two ground conductors to ensure proper connectivity to ground. Ideally these are connected directly to two ground electrodes, but connection to the perimeter ground cabling, as shown, is also acceptable.
2. The grounding points for the instrumentation is shown connected to the perimeter ground cabling rather than directly to a ground electrode. This is acceptable provided that electrical equipment is not grounded at a point between it and the nearest ground electrode. It is preferred to have direct connections to a ground electrode.
3. The grounding point for the intrinsically safe equipment is shown connected directly to a ground electrode, which is the preferred method due to the sensitivity of intrinsically safe equipment. If this is not feasible, it may be connected to the perimeter ground cabling provided that no electrical equipment is grounded at a point on the perimeter ground between it and the nearest ground electrode.
4. Duplicate grounded conductors are provided for the Intrinsically Safe ground bus bar for safety reasons.

20.3 Minimum Requirements

Panels containing I/O, 24 Vdc power supplies, and/or shielded network cabling shall be grounded as per the requirements indicated in Section 12.7.

	Automation Design Guide	Revision: 03	Page 107 of 132
		Document Code: 612620-0013-40ER-0001	

Automation panels that are grounded to an instrumentation grounding point shall each have an independent bonding conductor to the grounding point, and not be connected in series with one-another.

Panels containing grounded intrinsically safe associated apparatus (IS barriers) shall have duplicate (redundant) bonding conductors between the IS panel and the grounding point, and not be connected in series with one-another.

Automation junction boxes and panels without I/O, 24 Vdc power supplies, or shielded network cabling shall be grounded to the building electrical (safety) ground only.

20.4 Good Practices

New buildings should be provided with an instrumentation grounding point, and if required, an IS master grounding point if practicable. Note that it may not be feasible to unearth the existing grounding electrodes for direct connection of new instrumentation and/or IS ground buses. In this case, these grounding points would be connected as close as possible to the ground electrodes.

Grounded associated apparatus (Zener barriers) should be connected directly to an intrinsic safety (IS) master ground bus or a building ground electrode. Refer to Section 18.3.2 for further information on grounded associated apparatus.

	Automation Design Guide	Revision: 03	Page 108 of 132
		Document Code: 612620-0013-40ER-0001	

21 AUTOMATION ROOMS

21.1 Location of Equipment

21.2 General Requirements

Requirements of automation rooms include the following:

1. Ensure bare concrete floors are covered, painted, or sealed to reduce the build-up of concrete dust on automation equipment. Use of conductive surface hardeners for concrete floors is not permissible.
2. Locate automation rooms a minimum of 150mm above outdoor grade level.
3. Where automation rooms are subject to potential flood risk from a nearby process upset, locate the electrical room a minimum of 100 to 150 mm above the process floor level, or higher as required, to prevent a process flood incident from flowing into the electrical room.
4. No process piping shall run through the automation room.
5. No washroom or kitchen facilities shall be allowed directly above an automation room.
6. Hot water or glycol heating pipes or heaters shall not be located above automation rooms or anywhere such that a leak of liquid or steam could conceivably enter an automation room.
7. Evaporating coils for air handling units will be located and arranged to prevent condensation from running onto automation equipment in the event of a plugged drain.
8. Housekeeping pads:
 - 8.1 It is generally preferred that automation equipment be installed on housekeeping pads. Housekeeping pads are required in any application where there is potential for water leakage on the floor.
 - 21.2.1.8.1.1 Housekeeping pads may be omitted where not compatible with certain types of draw-out switchgear.
 - 8.2 Size housekeeping pads to extend 50mm past the equipment.
 - 8.3 Housekeeping pads to be between 110 and 152 mm high.
 - 8.4 Provide rebar as structurally required, but at minimum provide 10M rebar spaced at maximum 300 on center and anchor to the floor.

21.3 Space and Location Requirements

1. Design new automation rooms to provide a minimum of 25% usable floor space not allocated to installed equipment at the end of the project. In addition, a minimum of 10% of usable wall space shall be spare. This space provision shall not be utilized for equipment that only becomes defined as the project progresses.

Note: A common issue is that not all the electrical and automation equipment are known at the time of electrical room sizing. Automation room sizing at the preliminary design stage may need to be 150 – 200% of the size required for the equipment known at this stage. Consider undefined requirements at the time of automation room sizing.

	Automation Design Guide	Revision: 03	Page 109 of 132
		Document Code: 612620-0013-40ER-0001	

22 ENGINEERING DESIGN TEAM RESPONSIBILITY

22.1 General

1. Responsibility for deliverables:
 - 1.1 All drawings and other deliverables related to a design are the responsibility of the design engineer.
 - 1.2 The design team shall verify the make/model numbers used in this document are the most recent, compatible versions of the product offering.
2. All automation deliverables are to be sealed by a qualified professional engineer.
 - 2.1 The commissioning of the local SCADA system (HMI, workstations, etc.) shall be completed prior to the commissioning of any process area. If new servers and/or historians are added as part of the project they should be also be commissioned prior to the commissioning of process areas.
3. Completeness of drawings:
 - 3.1 All drawings shall be comprehensive in nature to allow for effective use in construction and maintenance.
4. Update of existing drawings:
 - 4.1 If the project is an addition, expansion, upgrade, or modification to an existing site or facility, existing drawings may require up-dating.
 - 4.1.1 Loop drawings, motor schematics, and wiring diagrams must always be updated.
 - 4.1.2 PLC system I/O schematic drawings must always be updated.
 - 4.1.3 Updates to or superseding existing P&ID drawings is mandatory. Partial P&ID diagrams showing a small portion of the process modifications are not acceptable.
 - 4.1.4 The update of existing instrument plan drawings to reflect new work is not typical, and is not required unless specifically identified by the City.
 - 4.1.5 The update of other existing automation drawings is dependent upon the design engineer's scope.
5. As-Built Drawings:
 - 5.1 All automation deliverables shall be updated to "as-built" status at the end of the project. The "as-built" documents shall incorporate contractor mark-ups, inspections performed by the design team, change orders, RFIs, and other communication between the Contractor and Design Team.
 - 5.2 Unless otherwise specified by the City and agreed to by the Design Team, as-built drawings will not be sealed (otherwise known as record drawings).
6. Site Visits:
 - 6.1 The design team is responsible for ensuring that a sufficient number of site visits occur to facilitate the understanding of specific field conditions or status of existing facilities and equipment.
7. Demolition Requirements:

	Automation Design Guide	Revision: 03	Page 110 of 132
		Document Code: 612620-0013-40ER-0001	

- 7.1 It is generally required that the design engineer is responsible for associated demolition works required to implement the scope of work. Clearly indicate all demolition requirements on the drawings and in the specifications.
 - 7.2 Where demolition requirements are significant, create dedicated demolition drawings.
 - 7.3 Generally, abandoned equipment, wiring, etc. shall be removed unless specifically requested by the City that the equipment/wiring be retained, or removal is not practicable.
8. Acceptance Testing:
- 8.1 Acceptance testing requirements shall be defined for every project. Acceptance tests shall use industry approved methods.
 - 8.2 Acceptance testing forms shall be completed for every project and included with the O&M manuals/Information.
 - 8.3 The Design Team is responsible for reviewing the completed acceptance test forms to ensure that the installation complies with the specifications.

22.2 Drawings

The drawing requirements in this section are not exhaustive, but indicate general requirements for all projects, as applicable to the scope of work in the project. The automation drawings produced shall be comprehensive to cover the scope of the project, and shall be detailed to an “industrial” level of detail. “Commercial-grade” drawings that have excessive use of “typical” and general lack of detail are not acceptable.

All drawings that are converted to PDF must be searchable.

22.2.1 Architecture Block Diagrams

A High-level view of networks, showing interconnections (routers/firewalls), servers, workstations, printers etc. for SCADA system, and PLCs, devices etc. for control/device networks.

22.2.2 Loop Drawings

1. Requirement:
 - 1.1 Loop Drawings are required for all field instruments that connect to a local control panel or programmable automation controller.
2. Content:
 - 2.1 Divide the drawing into columns such that each column represents a physical location. Title each column with the physical location it represents.
 - 2.2 Clearly show all instruments, terminals, devices, and wiring interconnections in each instrument loop.
 - 2.3 Provide all instrument and/or device settings on the loop drawing, such as dip switch settings, dial settings, etc.
 - 2.4 For analog loops, such as 4-20 mA and 0-20 mA loops, where there are multiple load devices within the loop, indicate the impedance of each device in the loop.
 - 2.5 Indicate the source of power (and common / neutral connections) for all loops.

	Automation Design Guide	Revision: 03	Page 111 of 132
		Document Code: 612620-0013-40ER-0001	

- 2.6 Provide an appropriate symbol within each special terminal to indicate the type of terminal:
 - 2.6.1 Indicate fused terminals with a small fuse symbol inside the terminal. Provide the fuse rating below the terminal.
 - 2.6.2 Indicate disconnect terminals with a small disconnect symbol inside the terminal.
 - 2.6.3 Indicate potential earth terminals with a small ground symbol inside the terminal.
- 2.7 Show the instrument identifier within an instrument bubble symbol adjacent to and pointing at the instrument.
- 2.8 Show all field instrument and control panel device part numbers on loop drawings.
- 2.9 For intrinsically safe wiring, indicate the following:
 - 2.9.1 The classification of the hazardous location (e.g. Class I, Zone 1, Group IIC),
 - 2.9.2 For intrinsically safe apparatuses (field devices) other than simple devices, the manufacturer, model, and entity parameters of the apparatus,
 - 2.9.3 Manufacturer/model and/or permissible entity parameters of the associated apparatus (e.g. IS barrier),
 - 2.9.4 Maximum entity values for the cabling.
- 3. Format:
 - 3.1 All loop drawings are to be produced on a standard B size drawing.
 - 3.2 Drawing Scale: NTS
- 4. Standard of acceptance:
 - 4.1 Refer to sample Instrument Loop Diagram, drawing SK-A103.

22.2.3 Instrument Segment Drawings

- 1. Requirement:
 - 1.1 Instrument Segment Drawings shall be prepared for every project utilizing PROFIBUS instruments.
- 2. Content:
 - 2.1 All new PROFIBUS instruments shall be shown on the instrument segment drawings.
 - 2.2 Indicate all instrument and networking equipment identifiers.
 - 2.3 Indicate the cable identifier and cable type for each cable on the drawing.
 - 2.4 Indicate the estimated length for all cables on the drawing.
 - 2.5 Indicate allowable minimum and/or maximum cable lengths on the drawing where applicable.
 - 2.6 Indicate the network speed(s) on the drawing.
 - 2.7 Indicate the location and type of terminations on the drawing.
 - 2.8 Indicate the network address number of each device on the drawing.
 - 2.9 Provide a Segment Schedule on the drawing, showing the number of devices, total length, and maximum spur length for each segment.

	Automation Design Guide	Revision: 03	Page 112 of 132
		Document Code: 612620-0013-40ER-0001	

3. Format:
 - 3.1 All instrument segment drawings are to be produced on a standard B size drawing.
 - 3.2 Drawing Scale: NTS
4. Standard of acceptance:
 - 4.1 Refer to sample Instrument Segment Diagram, drawing SK-A105.

22.2.4 Instrument Location Plan Drawings

1. Requirement:
 - 1.1 Instrument Location Plan Drawings shall be prepared for every project.
2. Content:
 - 2.1 All new instruments shall be shown on instrument location plan drawings.
 - 2.2 Provide instrument elevation drawings for instruments that are to be installed at a specific elevation and where sufficient detail cannot be provided in plan view.
 - 2.3 All instrument identifiers are to appear on the drawings.
 - 2.4 All mechanical equipment, if applicable, shall be shown with a lighter line weight.
3. Format:
 - 3.1 All instrument plan and elevation drawings are to be produced on a standard A1 size drawing.
 - 3.2 Drawing Scale:
 - 3.2.1 Recommended: 1:30

22.2.5 Instrument Installation Details

1. Requirement:
 - 1.1 Instrument installation details shall be provided for all instruments that require a specific means of installation.
 - 1.2 Specific (non-typical) installation details are required for all magnetic flow meter installations where the flow-tube is 350 mm (14") or larger, where remote transmitters are used, or where specific site constraints must be addressed. Typical installation details may be used for flow meter installations where the flow-tube is 300 mm (12") or smaller, with an integral transmitter, and without any site constraints.
 - 1.3 Typical installation details may be provided for ultrasonic level transducer installations unless a specific site constraint must be addressed.
 - 1.4 Specific installation details shall be provided for all differential pressure-based level transmitter installations.
2. Content:
 - 2.1 Show all installation details including instrument orientation, mounting bracketry, cables, conduits, strain reliefs, pull boxes, and junction boxes as applicable.
 - 2.2 For magnetic flow meter installations, show grounding ring installation and connection details.
 - 2.3 All structural and mechanical equipment, if applicable, shall be shown with a lighter line weight.

	Automation Design Guide	Revision: 03	Page 113 of 132
		Document Code: 612620-0013-40ER-0001	

3. Format:
 - 3.1 Instrument installation details are typically shown as a detail on a standard A1 size drawing.
 - 3.2 Drawing Scale:
 - 3.2.1 Recommended: 1:10
 - 3.2.2 Maximum: 1:20

22.2.6 Control Panel Layouts

1. Requirement:
 - 1.1 Provide control panel layout drawings for all control panels that are to be constructed by a Contractor or where included in the project scope.
2. Content:
 - 2.1 Provide a bill of materials, indicating the quantities, manufacturer name, model name, and a description for each component.
 - 2.2 Show exterior panel dimensions.
 - 2.3 Show the exterior (typically the front door only) elevation of the control panel with all components to scale.
 - 2.4 Show the interior elevation panel layout of all components to scale. The only component not shown on the layout shall be the wires.
 - 2.5 Where dedicated wireways are required, indicate the type or category of wiring that may be installed in each wireway.
 - 2.6 For each terminal block, indicate which side is for field wiring side and which side is for internal wiring.
 - 2.7 Provide construction notes indicating specific construction details.
3. Format:
 - 3.1 All control panel layout drawings are to be produced on a standard A1 size drawing.
 - 3.2 Drawing Scale:
 - 3.2.1 Recommended: 1:4
 - 3.2.2 Maximum: 1:10
4. Standard of acceptance:
 - 4.1 Refer to sample Control Panel Layout, drawing SK-A101.

22.2.7 Control Panel Power Distribution Schematics

1. Requirement:
 - 1.1 Control panel power distribution schematics shall be provided for all control panels.
2. Content:
 - 2.1 Show the complete schematic for the power distribution, including component identifiers, terminals, terminal numbers, wires, and wire tags.
 - 2.2 Show where the source of power terminates to the control panel, and include the name and details of the power source (e.g. "120 VAC from PNL-R731, CCT 12").

	Automation Design Guide	Revision: 03	Page 114 of 132
		Document Code: 612620-0013-40ER-0001	

- 2.3 Provide a fuse schedule on the drawing which lists the identifier, type, and rating of each fuse.
- 2.4 Provide a power consumption schedule for each major voltage level used within the control panel that summarizes the current consumption from each device, including PLC inputs and outputs. The total current consumption shall be provided at the bottom of the table.
- 2.5 Provide a terminal layout (arrangement) on the drawing for terminal blocks associated with power distribution.
3. Format:
 - 3.1 All control panel power distribution schematics shall be produced on a standard A1 size drawing.
4. Standard of acceptance:
 - 4.1 Refer to sample PLC Power Schematic, drawing SK-A102 (Sheets 001 and 002).

22.2.8 I/O Module Wiring Diagrams

1. Requirement:
 - 1.1 I/O module wiring diagrams shall be provided for all programmable automation controller I/O modules.
2. Content:
 - 2.1 Show the I/O modules and their connections to the I/O (field) terminals. The field instruments and associated wiring to the I/O (field) terminals shall not be shown on I/O module wiring diagrams. The field wiring details must be shown on loop drawings or other automation / electrical diagrams.
 - 2.2 Provide the I/O signal name and drawing reference beside each set of I/O (field) terminals associated with each I/O point.
 - 2.3 Where fused I/O (field) terminals are used, provide a fuse schedule which lists the identifier, type, and rating of each fuse.
3. Format:
 - 3.1 All I/O module wiring diagrams shall be produced on a standard A1 size drawing.

22.2.9 Network Diagrams

1. Requirement:
 - 1.1 Network diagrams shall be provided for all new network equipment installations.
 - 1.2 Use an Instrument Segment Drawing for all PROFIBUS instrumentation network drawings. See Section 22.2.3.
 - 1.3 Existing network diagrams shall be updated where changes are made to an existing network.
2. Content:
 - 2.1 Network diagrams shall show all networking equipment, including patch panels, network switches, routers, media converts, wireless devices, and cabling.
 - 2.2 The port type (RJ45, FC, LC, ST, SC, etc.) shall be identified on the drawing using a specific symbol.

	Automation Design Guide	Revision: 03	Page 115 of 132
		Document Code: 612620-0013-40ER-0001	

- 2.3 All port labels and/or port numbers for networking devices shall be indicated on the drawing in a manner that is consistent with the physical port labelling on the device.
- 2.4 All cable identifiers are to be shown on the drawing along with the cable types:
 - 2.4.1 For copper network cables, indicate the number of conductors, conductor size, and type of cable. Example: "4 PR, 24 AWG, CAT 6".
 - 2.4.2 For fibre cables, indicate the type of fibre (single-mode, multi-mode, hybrid, etc.) number of strands, core diameter, cladding diameter, and signal compatibility.
- 2.5 For long runs of fibre or CAT6 Ethernet cabling, indicate the estimate length of the cabling on the drawing.
- 2.6 For Ethernet Networks, indicate the IP addresses of the devices on the drawing.
Note IP addresses are not to be made available to the public.
- 2.7 For Modbus/TCP, Modbus/RTU (serial), or other networks utilizing "Node" numbers, indicate all device node numbers on the drawing.
- 2.8 For outdoor wireless systems, show all antennae and lightning surge arrestors.
- 2.9 Provide a symbol legend on the drawing or on a standard legend sheet.
- 3. Format:
 - 3.1 All network diagrams shall be produced on a standard A1 size drawing.
- 4. Reference:
 - 4.1 Standard of acceptance: sample network diagram, SK-A104.

22.2.10 Automation Conduit Riser Diagrams

- 1. Requirement:
 - 1.1 Where conduit sizing for the provision for future wiring is required, an automation conduit riser diagram shall be provided so that conduits are installed with the required spare capacity, and not sized by the installation contractor to the minimum size required by Code.
- 2. Content:
 - 2.1 Show the conduit type and size for each conduit.
 - 2.2 Show pull boxes, junction boxes, and panels as required.
 - 2.3 Show area boundaries using boundary lines and show each pull box, junction box, and panel within the appropriate boundaries.
 - 2.4 Provide a legend on the drawing or a standard legend sheet indicating the acronyms used. Examples:
 - ARC Aluminum Rigid Conduit
 - LFMC Liquidtight Flexible Metallic Conduit
 - PB Pull Box
 - PVC Polyvinyl Chloride
- 3. Format:
 - 3.1 All automation conduit riser diagrams are to be produced on a standard A1 size drawing.

	Automation Design Guide	Revision: 03	Page 116 of 132
		Document Code: 612620-0013-40ER-0001	

22.2.11 Process and Instrumentation Diagrams

Note: Process and Instrumentation Diagrams are officially categorized under the Process discipline, but rely heavily on input from automation engineers.

1. Requirement:
 - 1.1 Process and Instrumentation Diagrams shall be provided for all processes including HVAC and Building Services.
2. Content:
 - 2.1 Show the following automation details on P&IDs:
 - 2.1.1 Instrument balloons for all discrete instruments (i.e. those that are not a subcomponent to a parent piece of equipment).
 - 2.1.2 Alarm switch setpoints for all instruments used for alarming (e.g. temperature alarm setpoint for a TSH).
 - 2.1.3 Manual control devices (pushbuttons, switches, pilot lights, etc.) associated with each piece of equipment. Type clarifications (e.g. HOA, HOR, L/O/R, E/S), shall be shown above Hand/Off/Auto, Hand/Off/Remote, Local/Off/Remote, and Emergency Stop switches.
 - 2.1.4 Physical I/O (represented by triangle symbol) associated with process control system or automatic controller, along with functional signal designations.
 - 2.1.5 Software control function blocks associated with equipment, which logically represent the control functionality provided by the PLC system or automatic controller. The major control loops shall be shown; however, the level of detail shall be managed such that the process is not lost in excessive automation detail. Note that the Control Narratives (Section 22.3.7) together with the Functional Requirements Specifications (Section 22.3.8) provide the complete control strategy.
 - 2.1.6 Major software interlocks and control signals between software control function blocks, as required. Where multiple PLCs or controllers provide control for one piece of equipment, indicate the controller identifier above each software control function block.
 - 2.1.7 Hardwired interlocks and control signals.
 - 2.1.8 Critical operating and alarm setpoints for major equipment.
 - 2.1.9 Indication of communication protocol (e.g. PB-DP, PB-PA, MB-E) for communications cabling.
3. Format:
 - 3.1 All process and instrumentation diagrams are to be produced on a standard A1 size drawing.
4. Design Responsibility:
 - 4.1 Where appropriate, P&IDs should be sealed by both the appropriate process engineer and the automation engineer.

22.3 Other Documents

The documentation requirements in this section are not exhaustive, but indicate general requirements for all projects, as applicable to the scope of work in the project. The automation documents produced

	Automation Design Guide	Revision: 03	Page 117 of 132
		Document Code: 612620-0013-40ER-0001	

shall be comprehensive and shall be detailed to an “industrial” level of detail. The design team shall verify the make/model numbers used in this document are the most recent, compatible versions of the product offering.

All documents converted to PDF format shall be searchable.

22.3.1 Instrument List

1. Requirement:
 - 1.1 An instrument list is required for every project where new instruments are installed.
2. Content:
 - 2.1 Provide an overall cover page, indicating client name, project title, document code, and document revisions. The cover page shall be sealed by the Design Engineer.
 - 2.2 The instrument list shall include the following fields:
 - 2.2.1 Instrument Tag (identifier)
 - 2.2.2 Description
 - 2.2.3 Communication (4-20mA, HART, PB DP, etc.)
 - 2.2.4 File name and version of associated EDDL/GSD/DTM, if applicable.
 - 2.2.5 Plan Drawing (reference to drawing number)
 - 2.2.6 P&ID Drawing (reference to drawing number)
 - 2.2.7 Schematic / Loop Drawing (reference to drawing number)
 - 2.2.8 Installation Detail Drawing (reference to drawing number)
 - 2.2.9 Mounting Method
 - 2.2.10 Supplied By (indicate which sub-trade should supply the instrument)
 - 2.2.11 Notes
 - 2.2.12 Revision of last change
3. Format:
 - 3.1 An instrument list shall be prepared in Microsoft Excel, but other formats may be accepted by the City with approval.
4. Standard of acceptance:
 - 4.1 Refer to sample Instrument List, document SD-A101.

22.3.2 Loop Numbering List

1. Requirement:
 - 1.1 A Loop Numbering List lists all of the loop numbers used at each facility to prevent inadvertent duplication of loop numbers and equipment identifiers.
 - 1.2 A Loop Numbering List is required for all projects where new equipment is installed.
 - 1.3 The Loop Numbering List shall be divided by process area.
2. Content:
 - 2.1 The Loop Numbering List shall include the following fields:

	Automation Design Guide	Revision: 03	Page 118 of 132
		Document Code: 612620-0013-40ER-0001	

- 2.1.1 Loop Number
- 2.1.2 Loop/Equipment Description
- 2.1.3 Reference Drawings (e.g. loop drawings, P&ID drawings)
- 2.1.4 Notes
- 2.1.5 Revision of last change

22.3.3 I/O List

1. Requirement:
 - 1.1 An I/O list is required for every project where changes to PLC system I/O are made.
 - 1.2 Where possible, update an existing facility I/O list rather than creating a new I/O list. Alternatively, update the existing facility I/O list upon completion of the project.
2. Content:
 - 2.1 Provide an overall cover page, indicating client name, project title, document code, and document revisions. The cover page shall be sealed by the Design Engineer.
 - 2.2 I/O lists shall include the following fields:
 - 2.2.1 I/O Module Address (e.g. rack number and/or slot number)
 - 2.2.2 Module Point (I/O point number or channel number on module)
 - 2.2.3 Tag (instrument or signal tag name) (previous/superseded name if applicable)
 - 2.2.4 Description
 - 2.2.5 For discrete I/O:
 - 2.2.5.1 "0 State" Description (description of signal when FALSE)
 - 2.2.5.2 "1 State" Description (description of signal when TRUE)
 - 2.2.5.3 Indicate which state is used for alarms (if applicable)
 - 2.2.6 For analog I/O:
 - 2.2.6.1 Type (4-20mA, 0-5 VDC, 0-10 VDC, etc.)
 - 2.2.6.2 EU Range (engineering units range) including raw min and max if scaling occurs in SCADA rather than in the PLC. Indicate engineering unit of measure
 - 2.2.7 P&ID drawing (reference to applicable P&ID drawing)
 - 2.2.8 Loop/wiring drawing (reference to applicable loop/wiring drawing)
 - 2.3 The list shall be grouped by I/O signal type:
 - 2.3.1 Discrete Input
 - 2.3.2 Discrete Output
 - 2.3.3 Analog Input
 - 2.3.4 Analog Output
 - 2.3.5 HART Input
 - 2.3.6 HART Output

	Automation Design Guide	Revision: 03	Page 119 of 132
		Document Code: 612620-0013-40ER-0001	

3. Format:
 - 3.1 An I/O list will typically be prepared in Microsoft Excel, but other formats may be accepted by the City with approval.
4. Standard of acceptance:
 - 4.1 Refer to sample I/O List, document SD-A012.

22.3.4 Interface Maps

1. Requirement:
 - 1.1 Interface maps are required for projects where a new customizable controller is installed and makes data available to other controllers via a communication link. For example, a new standalone PLC is installed for an HVAC system, which is monitored by the facility PLC system using Modbus TCP.
2. Preparation and Completion:
 - 2.1 For non-packaged systems, preparation of interface maps falls under the responsibility of the Systems Integrator. The Design Engineer may provide templates to the Systems Integrator for completion.
 - 2.2 For packaged systems including equipment and a programmable controller or HMI, preparation of interface maps falls under the responsibility of the vendor.
3. Content:
 - 3.1 Interface maps shall include an overall cover page, indicating client name, project title, document code, and document revisions.
 - 3.2 Interface maps shall include the following fields:
 - 3.2.1 PLC Register or PLC Tag name,
 - 3.2.2 Protocol Address (e.g. Modbus address),
 - 3.2.3 Description,
 - 3.2.4 Analog Range – Raw,
 - 3.2.5 Analog Range – Engineering Units,
 - 3.2.6 Read/Write,
 - 3.2.7 In the case of packaged control systems alarm limits should also be indicated
 - 3.2.8 Digital I/O, should identify, register number and bit number and 1 and 0 states (alarm, etc.)
 - 3.2.9 Notes.
4. Format:
 - 4.1 An interface map will typically be prepared in Microsoft Excel, but other formats may be accepted by the City with approval.
5. Standard of acceptance:
 - 5.1 Refer to sample Interface Map, document SD-A103.

22.3.5 Automation Cable Schedule

1. Requirement:

	Automation Design Guide	Revision: 03	Page 120 of 132
		Document Code: 612620-0013-40ER-0001	

- 1.1 An automation cable schedule is required for every project.
2. Content:
 - 2.1 Provide an overall cover page, indicating client name, project title, document code, and document revisions. The cover page shall be sealed by the Design Engineer.
 - 2.2 All control cables shall be uniquely identified on the cable schedule. Cables shall not be entered as typical.
 - 2.3 Where individual wires are routed in conduit, the wires shall be identified as an item in the cable schedule. This is not applicable to power wiring for minor circuits, such as lighting, receptacles, etc.
 - 2.4 Cable schedules shall include the following fields:
 - 2.4.1 Cable Identifier
 - 2.4.2 Cable Type
 - 2.4.3 From (Source)
 - 2.4.4 To (Destination)
 - 2.4.5 Spacing (typically not applicable to automation cabling)
 - 2.4.6 Length (estimate)
 - 2.4.7 Routing (brief description)
 - 2.4.8 Notes
 - 2.4.9 Revision of last change.
 - 2.5 The length for each cable shall be estimated at design time to within ~10% accuracy for purposes of pre-bid cost estimating.
3. Format:
 - 3.1 A cable schedule will typically be prepared in Microsoft Excel, but other formats may be accepted by the City with approval.
4. Standard of acceptance:
 - 4.1 Refer to sample Automation Cable Schedule, document SD-A104.

22.3.6 Lamacoid Schedule

1. Requirement:
 - 1.1 A lamacoid schedule is a requirement for every project.
 - 1.2 Note that the creation of a lamacoid schedule at design time greatly assists the Contractor, helps provide a higher quality of identification lamacoids for maintenance personnel, and can be created for a minimum effort above that required to thoroughly review a Contractor-produced lamacoid schedule.
2. Content:
 - 2.1 Provide an overall cover page, indicating client name, project title, document code, and document revisions.
 - 2.2 All automation lamacoids shall be uniquely identified on the lamacoid schedule, except as follows:
 - 2.2.1 Lamacoids for cables may reference the cable schedule.

	Automation Design Guide	Revision: 03	Page 121 of 132
		Document Code: 612620-0013-40ER-0001	

2.3 Lamacoid schedules shall at minimum include the following fields:

- 2.3.1 Item
- 2.3.2 Line 1 (text to appear on row 1)
- 2.3.3 Line 2 (text to appear on row 2)
- 2.3.4 Line 3 (text to appear on row 3)
- 2.3.5 Text size
- 2.3.6 Notes
- 2.3.7 Revision of last change.

3. Format:

3.1 A lamacoid schedule will typically be prepared in Microsoft Excel, but other formats may be accepted by the City with approval.

4. Standard of acceptance:

4.1 Refer to sample Lamacoid Schedule, document SD-A105.

22.3.7 Process Control Narrative

1. Requirement:

- 1.1 Provide a Process Control Narrative for all projects where new process equipment is installed.
- 1.2 While this document is primarily written by process engineers, the automation engineers should review and provide input.

2. Content:

- 2.1 Provide an overall cover page, indicating client name, project title, document code, and document revisions.
- 2.2 Provide a listing of reference drawings (typically P&IDs).
- 2.3 Provide equipment and instrument listing, complete with identifiers (tag numbers) and descriptions.
- 2.4 Provide a detailed textual description of all the control modes of the process.
- 2.5 Indicate general arrangement details, such as equipment physical locale and configuration where required to clarify the process control.
- 2.6 For each operating mode describe the normal operation of each piece of equipment.
- 2.7 Describe the operation of equipment under abnormal circumstances (e.g. instrument failure, mechanical failure, etc.), where possible.
- 2.8 Indicate special requirements of the automation system to accommodate maintenance activities, as required.
- 2.9 Indicate operating setpoints for each operating mode.
- 2.10 Indicate process interlocks and equipment protection interlocks.
- 2.11 Indicate required minor and major alarms.

	Automation Design Guide	Revision: 03	Page 122 of 132
		Document Code: 612620-0013-40ER-0001	

3. Format:

- 3.1 A process control narrative will typically be prepared in Microsoft Word, but other formats may be accepted by the City with approval.

22.3.8 Functional Requirements Specifications

An Enhanced Process Control Narrative (PCN) and function block manual should be developed for all new or migrated areas instead of Functional Requirements Specifications.

22.4 Construction and Commissioning Documents

22.4.1 Instrument Test Forms

1. Requirement:

- 1.1 Instrument test forms shall be provided with projects where new instruments will be installed. Checklists shall be formatted to contain all deliverables of the design requirements.

2. Preparation and Completion:

- 2.1 Instrument test forms shall be prepared by the Design Engineer and filled in by the installation contractor.
- 2.2 Use standard City forms where available.

3. Content:

- 3.1 Provide a header section at the top of the test form with the following fields, to be filled in by the contractor:
- 3.1.1 Facility
 - 3.1.2 Project Name
 - 3.1.3 Plant Area
 - 3.1.4 Bid Opportunity number
 - 3.1.5 Document number
- 3.2 Provide a sign-off section at the bottom. Test forms are to be signed and dated by the tester and a witness, where the witness is a person designated by the Contract Administrator.
- 3.3 Provide sections for filling in the following:
- 3.3.1 Sensor / element and transmitter details indicating at minimum:
 - a. Units,
 - b. Design range,
 - c. Configured range,
 - 3.3.2 Inspection of instrument and installation.
 - 3.3.3 For discrete instruments:
 - a. The setpoint trip point,
 - b. The actual trip point,

	Automation Design Guide	Revision: 03	Page 123 of 132
		Document Code: 612620-0013-40ER-0001	

- c. The setpoint time delay,
 - d. The actual time delay, and
 - e. Verification of the signal for each discrete state.
 - 3.3.4 For analog instruments, verification of the signal under various process or test conditions.
 - 3.3.5 For PROFIBUS instruments, the communication is functioning without error, the transmitter alarms are configured (as required), and the transmitter configuration is complete and saved.
- 4. Format:
 - 4.1 Instrument test forms will typically be prepared in Microsoft Word, but other formats may be accepted by the City with approval.

22.4.2 I/O Module Test Forms

- 1. Requirement:
 - 1.1 I/O module test forms shall be provided for new PLC installations for verification that each I/O point and associated HMI object(s) are configured correctly. Checklists shall be formatted to contain all deliverables of the design requirements.
- 2. Preparation and Completion:
 - 2.1 I/O module test forms shall be prepared by the Design Engineer and filled in by the Systems Integrator as part of the FAT documentation.
 - 2.2 Use City standard forms where available.
- 3. Content:
 - 3.1 Provide a header section at the top with the following fields, to be filled in by the contractor:
 - 3.1.1 Facility
 - 3.1.2 Project Name
 - 3.1.3 Plant Area
 - 3.1.4 Bid Opportunity number
 - 3.1.5 Document number
 - 3.2 Provide a sign-off section at the bottom. Forms are to be signed and dated by the tester and a witness, where the witness is a person designated by the Contract Administrator.
 - 3.3 Provide a section for filling in the associated PLC identifier, PLC description, rack number, slot number, and module type.
 - 3.4 Provide separate forms for each type of module (discrete input, discrete output, analog input, analog output, thermocouple input, RTD input, etc.).
 - 3.5 Provide columns within the forms for the I/O point number, I/O point tag name, I/O point description, 0 State (False state) description, 1 State (True state) description, and checkboxes for indicating that each state has been verified:
 - 3.5.1 at the PLC Input/output module,
 - 3.5.2 on the HMI graphic display, and

	Automation Design Guide	Revision: 03	Page 124 of 132
		Document Code: 612620-0013-40ER-0001	

3.5.3 on the HMI alarm system.

4. Format:

4.1 I/O module test forms will typically be prepared in Microsoft Word, but other formats may be accepted by the City with approval.

22.4.3 PLC System Commissioning Checklist

1. Requirement:

1.1 PLC system commissioning checklists shall be provided for new PLC installations for verification that each PLC system is installed and operating correctly. Checklists shall be formatted to contain all deliverables of the design requirements.

2. Preparation and Completion:

2.1 PLC system commissioning checklists shall be prepared by the Design Engineer and filled in by the Systems Integrator.

3. Content:

3.1 Provide a header section at the top with the following fields, to be filled in by the contractor:

3.1.1 Facility

3.1.2 Project Name

3.1.3 Plant Area

3.1.4 Bid Opportunity number

3.1.5 Document number

3.2 Provide a sign-off section at the bottom. Checklists are to be signed and dated by the tester and a witness, where the witness is a person designated by the Contract Administrator.

3.3 Provide a section for filling in the PLC identifier, PLC description, processor and network adapter module numbers, and rack number.

3.4 Provide a section indicating that the following has been inspected:

3.4.1 PLC cabinet is completely clean and there are no loose papers inside.

3.4.2 Ventilation openings are not covered.

3.4.3 Drawings are marked up as-built.

3.4.4 Communications between PLC and HMI system are acceptable.

3.4.5 Communications between PLC and remote racks are acceptable, as applicable.

3.4.6 For redundant PLC applications, failover functionality from primary rack to secondary (standby) rack, then back to primary, is operational.

3.4.7 Memory card(s) are installed and program has been transferred to the memory card(s), as applicable.

3.5 Provide a section for filling in the following run-time information:

3.5.1 Percentage processor (CPU) utilization.

3.5.2 Percentage memory utilization.

	Automation Design Guide	Revision: 03	Page 125 of 132
		Document Code: 612620-0013-40ER-0001	

3.5.3 Program scan time.

4. Format:

- 4.1 PLC system commissioning checklists will typically be prepared in Microsoft Word, but other formats may be accepted by the City with approval.

22.4.4 SCADA System Commissioning checklist

5. Requirement:

- 5.1 SCADA system commissioning checklists shall be provided for new SCADA installations for verification that each SCADA system is installed and operating correctly. Checklists shall be formatted to contain all deliverables of the design requirements.

6. Preparation and Completion:

- 6.1 SCADA system commissioning checklists shall be prepared by the Design Engineer and filled in by the Systems Integrator.

7. Content:

- 7.1 Provide a header section at the top with the following fields, to be filled in by the contractor:
- 7.1.1 Facility
 - 7.1.2 Project Name
 - 7.1.3 Plant Area
 - 7.1.4 Bid Opportunity number
 - 7.1.5 Document number
- 7.2 Provide a sign-off section at the bottom. Checklists are to be signed and dated by the tester and a witness, where the witness is a person designated by the Contract Administrator.
- 7.3 Provide a section for filling in the HMI/Server identifier, HMI/Server description, processor and network adapter module numbers, and rack number.
- 7.4 Provide a section indicating that the following has been inspected:
- 7.4.1 Redundancy check for redundant systems – we need to check and make sure all redundancy system works including the network.
 - 7.4.2 Ensure hardware meets COW specs.
 - 7.4.3 Ensure all required applications are installed on the servers and workstations/clients are working as designed.
 - 7.4.4 Ensure all SCADA server alarms are operational.
 - 7.4.5 Ensure the HMI and all graphic displays (i.e. header/footer, navigation, trends, alarms, etc.) are working/operational.
 - 7.4.6 There should be a commissioning checklist for all servers to ensure they are setup/working as designed.
 - 7.4.7 Test the thin clients (if applicable) to ensure they are working as designed.
 - 7.4.8 Test the networks (DMZ, Supervisory, Server, Primary and Secondary) to ensure they are working as designed.

	Automation Design Guide	Revision: 03	Page 126 of 132
		Document Code: 612620-0013-40ER-0001	

- 7.5 Provide a section for filling in any other commissioning checks applicable to the SCADA system.
- 8. Format:
 - 8.1 HMI system commissioning checklists will typically be prepared in Microsoft Word, but other formats may be accepted by the City with approval.

22.4.5 Valve Actuator Commissioning Checklist

- 1. Requirement:
 - 1.1 Valve actuator commissioning checklists shall be provided for all new valve actuator installations for verification that the valve actuator is correctly installed and configured. Checklists shall be formatted to contain all deliverables of the design requirements.
- 2. Preparation and Completion:
 - 2.1 Valve actuator commissioning checklists shall be prepared by the Design Engineer and filled in by the installation contractor.
- 3. Content:
 - 3.1 Provide a header section at the top with the following fields, to be filled in by the contractor:
 - 3.1.1 Facility
 - 3.1.2 Project Name
 - 3.1.3 Plant Area
 - 3.1.4 Bid Opportunity number
 - 3.1.5 Document number
 - 3.2 Provide a sign-off section at the bottom. Checklists are to be signed and dated by the tester and a witness, where the witness is a person designated by the Contract Administrator.
 - 3.3 Provide a section for filling in the valve actuator details:
 - 3.3.1 Identifier (tag)
 - 3.3.2 Description
 - 3.3.3 Manufacturer
 - 3.3.4 Model
 - 3.3.5 Serial Number
 - 3.3.6 Design Range
 - 3.3.7 PROFIBUS network address
 - 3.4 Provide a section indicating that the following has been inspected:
 - 3.4.1 Actuator type and materials matches the P&ID and actuator data sheet
 - 3.4.2 Installation of actuator is correct
 - 3.4.3 Equipment tag is correct

	Automation Design Guide	Revision: 03	Page 127 of 132
		Document Code: 612620-0013-40ER-0001	

- 3.4.4 Configuration matches valve actuator settings sheet
 - 3.4.5 Open/close/position command from process control system is functioning
 - 3.4.6 Status monitoring by process control system is functioning
 - 3.4.7 Drawings are marked up as-built
 - 3.4.8 HMI graphic symbol, tag, and units are correct
4. Format:
- 4.1 Valve actuator commissioning checklists will typically be prepared in Microsoft Word, but other formats may be accepted by the City with approval.

22.5 Design Calculations and Studies

1. All design decisions leading to important design activities, must be supported by an appropriate calculation, which may be required for verification and justification. The Design Engineer shall prepare design calculations as required. It shall be the responsibility of the Design Team to collect, verify, and file all such calculations.
2. The software tools or vendor PLC packages used for the required calculations must be approved by the Lead Engineer for each specific project.
3. Calculations done by subcontractors, contractors or vendors will be permitted if the calculation requires specialized knowledge or experience that a typical automation design engineer would not possess. In these cases, it is the responsibility of the design engineer to ensure that the calculations follow all City standards and guidelines.
4. The calculations and studies shall only be deferred to the Contractor after review and agreement with the City.
5. The following are potential calculations that may be required by the design engineer depending on the size and complexity of the design:
 - 5.1 New control panels, power supply panels, networking panels:
 - 5.1.1 Wireway sizing / fill calculations, where there are a significant number of wires in the wireways and the percent fill is non-trivial,
 - 5.1.2 Heat load calculations,
 - 5.1.3 Power supply loading calculations,
 - 5.2 New junction boxes:
 - 5.2.1 Wireway sizing / fill calculations, where there are a significant number of wires in the wireways and the percent fill is non-trivial.
 - 5.3 Intrinsically safe installations:
 - 5.3.1 Indication of manufacturer, model number, and entity parameters of the intrinsically safe apparatus as they apply to the specific set(s) of terminals to be connected.
 - 5.3.2 Indication of manufacturer, model number, and entity parameters of the associated apparatus as they apply to the specific set(s) of terminals to be connected.
 - 5.3.3 Calculation of maximum allowable interconnecting cable entity parameters.
 - 5.4 Cable tray installations:

- 5.4.1 Cable tray sizing (volume) and loading (weight) calculations.
- 5.5 Conduit installations:
 - 5.5.1 Conduit fill calculations.
- 5.6 Safety Integrity Calculations as per Section 19.
- 5.7 Profibus installations:
 - 5.7.1 Bus voltage drop calculations.
 - 5.7.2 Bus current (loading) calculations.
 - 5.7.3 Max bus cable length (trunk and spur) calculations based on network speed and topology.
- 6. All design calculations relating to process control system performance and utilization should be included in the Operation and Maintenance Manuals for the associated areas.

 Winnipeg	Automation Design Guide	Revision: 03	Page 129 of 132
		Document Code: 612620-0013-40ER-0001	

23 SAMPLE DRAWINGS

SK-A101	Control Panel Layout
SK-A102	PLC Power Schematic
SK-A103	Instrument Loop Diagram
SK-A104	Network Diagram
SK-A105	Instrument Segment Diagram

24 SAMPLE DOCUMENTS

SD-A101	Instrument List
SD-A102	I/O List
SD-A103	Interface Map
SD-A104	Automation Cable Schedule
SD-A105	Lamacoid Schedule
SD-A106	Functional Requirements Specification: Area "A" – Standard Function Block Classes
SD-A107	Functional Requirements Specification: Area "S" – Secondary Clarifiers



Automation Design Guide

Revision: 03 Page 131 of 132

Document Code: 612620-0013-40ER-0001



Automation Design Guide

Revision: 03 Page 132 of 132

Document Code: 612620-0013-40ER-0001